



---

# Instruction Manual



## ***ECOR Series DVR***

EVERFOCUS ELECTRONICS CORPORATION

# ECOR Series DVR

## Instruction Manual

---

© 2008 EverFocus Electronics Corp  
[www.everfocus.com](http://www.everfocus.com)

All rights reserved. No part of the contents of this manual may be reproduced or transmitted in any form or by any means without written permission of the Everfocus Electronics Corporation.

**Release Date: May 2009**

Windows is a registered trademark of the Microsoft Corporation.

QuickTime is a registered trademark of the Apple Computer, Inc.

Linksys is a registered trademark of the Linksys Corporation.

D-Link is a registered trademark of the D-Link Corporation.

Other product and company names mentioned herein may be the trademarks of their respective owners.

## Safety Precautions

- To avoid any damage, please consider the following safety warnings:
- Never place the recorder near to heaters, furnaces, other heat sources or under direct solar irradiation.
- Operate the device only in locations providing the tolerable operating temperature range 0°C~40°C/32°F ~ +104°F.
- Make sure that the device's ventilation slots are not covered or sheeted.
- For cleaning, make sure the device is plugged off and only use a damp cloth without acid detergent.
- Install the device only in dry and dustproof surroundings. Protect the device against any liquid's penetration.
- Avoid the penetration of any artifacts, e.g. through ventilation slots.
- Do not attempt to disassemble the appliance. To prevent electric shock, do not remove screws or covers. There are no user-serviceable parts inside. Contact qualified service personnel for maintenance. Handle the appliance with care. Do not strike or shake, as this may damage the appliance.
- Do not operate appliance with other than specified power supplies. The input power source of the power supply is 12 VDC with external power supply 100 ~ 240 VAC.
- Avoid any affection of the device through vibrations or mechanical shock at the recorder's installation location.
- Avoid to power off DVR during playback or recording operation.



ATTENTION! This is a class A product which may cause radio interference in a domestic environment; in this case, the user may be urged to take adequate measures.



### **Federal Communication Commission Interference Statement**

This equipment has been tested and found to comply with the limits for a Class B digital device, pursuant to Part 15 of the FCC Rules. These limits are designed to provide reasonable protection against harmful interference in a residential installation. This equipment generates, uses and can radiate radio frequency energy and, if not installed and used in accordance with the instructions, may cause harmful interference to radio communications. However, there is no guarantee that interference will not occur in a particular installation. If this equipment does cause harmful interference to radio or television reception, which can be determined by turning the equipment off and on, the user is encouraged to try to correct the interference by one of the following measures :

- Reorient or relocate the receiving antenna.
- Increase the separation between the equipment and receiver.
- Connect the equipment into an outlet on a circuit different from that to which the receiver is connected.
- Consult the dealer or an experienced radio/TV technician for help.

FCC Caution: Any changes or modifications not expressly approved by the party responsible for compliance could void the users' authority to operate this equipment.



WEEE



This Product is RoHS compliant.

The information in this manual was current upon publication. The manufacturer reserves the right to revise and improve his products. Therefore, all specifications are subject to change without prior notice. Misprints reserved.  
Please read this manual carefully before installing and using this unit. Be sure to keep it handy for later reference.

# TABLE OF CONTENTS

<b>1</b>	<b>PRODUCT OVERVIEW .....</b>	<b>1</b>
1.1	FEATURES .....	1
1.2	PACKAGE CONTENTS .....	2
1.3	SPECIFICATIONS.....	3
1.4	FRONT PANEL .....	5
1.5	BACK PANEL .....	7
<b>2</b>	<b>INSTALLATION.....</b>	<b>9</b>
2.1	VIDEO CONNECTIONS .....	9
2.2	AUDIO CONNECTION INSTALLATION .....	9
2.3	ALARM INPUT / OUTPUT INSTALLATION.....	10
2.4	NETWORK CONNECTION.....	11
2.4.1	<i>Direct PC Connection through Crossover Network Cable.....</i>	<i>11</i>
2.4.2	<i>Network Connection through Patch Cable.....</i>	<i>11</i>
2.4.3	<i>Network System Requirements.....</i>	<i>12</i>
2.5	SPEED DOME INSTALLATION .....	12
2.6	FINAL INSTALL PROCESS .....	13
<b>3</b>	<b>MOUSE AND FRONT PANEL OPERATION .....</b>	<b>14</b>
3.1	GENERAL USB MOUSE OPERATION .....	14
3.1.1	<i>OSD Root Menu.....</i>	<i>14</i>
3.1.2	<i>Operation in Configuration Menu.....</i>	<i>15</i>
3.1.3	<i>Component Options .....</i>	<i>15</i>
3.2	GENERAL FRONT PANEL OPERATION .....	17
3.2.1	<i>Front Panel Key Review.....</i>	<i>17</i>
3.2.2	<i>Operation in Configuration Menu.....</i>	<i>17</i>
3.2.3	<i>Component Options .....</i>	<i>18</i>
<b>4</b>	<b>GENERAL DVR OPERATIONS.....</b>	<b>19</b>
4.1	RECORD.....	19
4.2	LOGIN.....	19
4.3	PLAYBACK OPERATION .....	21
4.3.1	<i>Playback.....</i>	<i>21</i>
4.3.2	<i>Reverse playback.....</i>	<i>21</i>
4.3.3	<i>Pause .....</i>	<i>21</i>
4.3.4	<i>Fast forward.....</i>	<i>21</i>
4.3.5	<i>Fast backward .....</i>	<i>22</i>
4.3.6	<i>Step forward .....</i>	<i>22</i>
4.3.7	<i>Step backward .....</i>	<i>22</i>
4.3.8	<i>Stop playback .....</i>	<i>22</i>
4.4	START SEQUENCE.....	22
4.5	LAYOUT CHANGE .....	23

4.5.1	<i>Layout Change</i> .....	23
4.5.2	<i>Bring to Full Screen Mode</i> .....	23
4.6	QUICK MENU .....	24
4.6.1	<i>Triplex Operation</i> .....	24
4.6.2	<i>Change Camera Order</i> .....	24
4.7	COPY .....	25
4.7.1	<i>Standard Copy</i> .....	25
4.7.2	<i>Quick Copy</i> .....	26
4.8	SEARCH .....	26
4.8.1	<i>Time Search</i> .....	27
4.8.2	<i>Event Search</i> .....	27
4.8.3	<i>Smart Motion Search</i> .....	28
4.8.4	<i>Search Result</i> .....	29
4.9	LOGOUT .....	31
<b>5</b>	<b>DVR CONFIGURATION</b> .....	<b>32</b>
5.1	OSD SETTING MENU .....	32
5.2	RECORD & PLAY SETTING .....	32
5.2.1	<i>Record</i> .....	32
5.2.2	<i>Play</i> .....	33
5.3	CAMERA SETTING .....	34
5.3.1	<i>Basic Setting</i> .....	34
5.3.2	<i>Video Adjust</i> .....	36
5.3.3	<i>Motion</i> .....	37
5.3.4	<i>Video Loss</i> .....	39
5.4	SCHEDULE SETTING .....	40
5.5	ALARM & EVENT SETTING .....	42
5.5.1	<i>Alarm</i> .....	42
5.5.2	<i>Event</i> .....	43
5.6	NETWORK SETTING .....	48
5.6.1	<i>LAN</i> .....	48
5.6.2	<i>EMAIL</i> .....	49
5.6.3	<i>DDNS</i> .....	50
5.7	DISK SETTING .....	51
5.8	DISPLAY SETTING .....	52
5.8.1	<i>Monitor OSD</i> .....	52
5.8.2	<i>Main M/T SEQ.</i> .....	53
5.9	SYSTEM SETTING .....	54
5.9.1	<i>Date/Time</i> .....	54
5.9.2	<i>Daylight Saving</i> .....	55
5.9.3	<i>User</i> .....	56
5.9.4	<i>Security</i> .....	57
5.9.5	<i>I/O Control</i> .....	58
5.9.6	<i>Firmware &amp; Misc.</i> .....	59
5.10	INFORMATION SETTING .....	60
5.10.1	<i>System</i> .....	60
5.10.2	<i>Log</i> .....	61
<b>6</b>	<b>NETWORKING OVERVIEW</b> .....	<b>63</b>

6.1	INTRODUCTION TO TCP/IP .....	63
6.2	SUBNET MASKS .....	63
6.3	GATEWAY ADDRESS .....	63
6.4	VIRTUAL PORTS.....	64
6.5	PRE-INSTALLATION .....	64
6.6	WHAT IS YOUR NETWORK SETUP?.....	65
6.7	SIMPLE ONE TO ONE CONNECTION.....	66
6.8	DIRECT HIGH SPEED MODEM CONNECTION .....	71
6.9	ROUTER OR LAN CONNECTION .....	73
<b>7</b>	<b>REMOTE OPERATION FROM BROWSER.....</b>	<b>76</b>
7.1	CONNECTING TO ECOR.....	76
7.2	IE BROWSER SETTING & ACTIVE X CONTROL INSTALLATION .....	77
7.2.1	<i>Installing ActiveX controls</i> .....	77
7.2.2	<i>Enabling ActiveX Controls</i> .....	79
7.3	REMOTE LIVE VIEW .....	82
7.4	REMOTE PTZ CONTROL .....	83
7.5	REMOTE PLAYBACK .....	84
<b>8</b>	<b>EVERFOCUS DDNS SETUP .....</b>	<b>85</b>
<b>9</b>	<b>LINKSYS &amp; D-LINK PORT FORWARDING .....</b>	<b>86</b>
9.1	LINKSYS PORT FORWARDING .....	86
9.2	D-LINK PORT FORWARDING.....	88
<b>10</b>	<b>TROUBLESHOOTING .....</b>	<b>91</b>
	<b>APPENDIX A: TIMING OF ALARM MODES.....</b>	<b>92</b>
	<b>APPENDIX B: CONTROL PROTOCOL.....</b>	<b>96</b>

# 1 Product Overview

The ECOR series DVR is based on MPEG-4 compression technology, resulting in enhanced recording capacity and improved network image transmission speed with high image quality. Comprehensive features and extended event recording settings enable the most universal application of this DVR series.

## 1.1 Features

- Pentaplex Operation (Simultaneously live, recording, playback, archive, and remote viewing)
- User friendly GUI with graphical icons and visual indicators
- Multiple Control Inputs: mouse/front panel/remote control/EKB500
- Free EverFocus DDNS service
- Remote configuration support from built-in web interface
- Smart Motion Search function
- Gigabit Ethernet interface for remote network viewing and controlling
- Real-time live display for all cameras
- Individual channel control on schedule recording
- USB 2.0 ports for video archive and mouse usage
- Multi-language support
- Watermark capabilities to identify intentional modifications of recorded data
- Simultaneous VGA and composite output\*
- Built-in DVD burner\*
- Audio recording capabilities\*

\*Functions not available in all models



## 1.2 Package Contents

Digital Video Recorder x1

User's Manual x1

AC Adapter and Power Cord x1

Handheld Remote Control (batteries included) x 1

Hard Drive Rack Mount x1 \*

SATA Connection Cable x1 \*

Pack of screws x 1 \*

\* marked accessories not included in some models

## 1.3 Specifications

Video Format	NTSC / PAL (auto detected by system)	
Operating System	Embedded Linux	
Video Input	ECOR4: 4 x 1 V <sub>pp</sub> FBAS, BNC, 75 Ohm ECOR8: 8 x 1 V <sub>pp</sub> FBAS, BNC, 75 Ohm	
Video Output	Main monitor: 1 V <sub>pp</sub> FBAS, BNC at 75 Ohm 1 x VGA ( res. 800x600@60 Hz)	
Video Compression	MPEG-4	
Video Display	Full screen, Picture In Picture (Live only), 4-channel, 9-channel (for 8 CH model only)	
Recording Resolution	NTSC: 704 x 480, 704 x 240 or 352 x 240 PAL: 704 x 576, 704 x 288 or 352 x 288	
Audio*	Input: 1 x Line In, 1 V <sub>pp</sub> @ 20 KOhm (RCA) Output: 1 x Line out 1 V <sub>pp</sub> @ 20 KOhm (RCA) (* audio models only)	
Alarm Inputs	ECOR4: 4 N.O/N.C ECOR8: 8 N.O/N.C	
Alarm Output	1 Alarm Output (N.C/COM/N.O)	
Hard Disk	1 x 3.5" SATA hard disk	
Recording Rate	NTSC 352 x 240: 240 IPS 704 x 240: 120 IPS 704 x 480: 60 IPS	PAL 352 x 288: 200 IPS 704 x 288: 100 IPS 704 x 576: 50 IPS
Recording Modes	Continuous, schedule, or event recording	
Playback Rate	NTSC 352 x 240: 240 IPS 704 x 240: 120 IPS 704 x 480: 60 IPS	PAL 352 x 288: 200 IPS 704 x 288: 100 IPS 704 x 576: 50 IPS

Playback Search Function	By time / date; by event (alarm / motion); Smart Motion Grid Search
Motion Detection	Adjustable by channel , 22x15 sensor fields each with 10 levels sensitivity
Video Loss Detection	Yes
Event Log	Up to 10000 events
Event Alarm	Fan failure, hard disk failure, hard disk temperature over, hard disk full
Setup	Graphical On-Screen-Display
Operation	Via front panel, USB optical mouse, or IR remote control RS-485 operation from EKB500
Real-time Clock	Internal with optional network synchronization (NTP server)
Watchdog Function	Yes
Network	10/100/1000Mbs, RJ45 connection
File Export	USB 2.0 interface Built-in DVD+RW (D models only)
RS-232	9-pin D-Sub socket
RS-485	Terminal connector
Power Source	12 VDC with external power supply 100 ~ 240 VAC
Power Consumption	60 W max
Dimensions	320 (W) x 208.9 (D) x 54.3 (H) mm ; 12.8" (W) x 8.35" (D) x 2.17" (H)
Weight	DVD model: 1.9 kg (4.2LBS); No DVD model: 1.65 kg (3.6LBS)
Ambient Temperature	0°C ~ 40°C ; 32°F ~ 104°F
Remote Control	Handheld IR remote control; RS-485 keyboard EKB-500 (optional)

## 1.4 Front Panel

Your primary interaction with your new DVR will be through the Front Panel buttons and their corresponding buttons on the included Remote Control. Take a moment to learn where the keys are as the remainder of the manual will refer to them often.

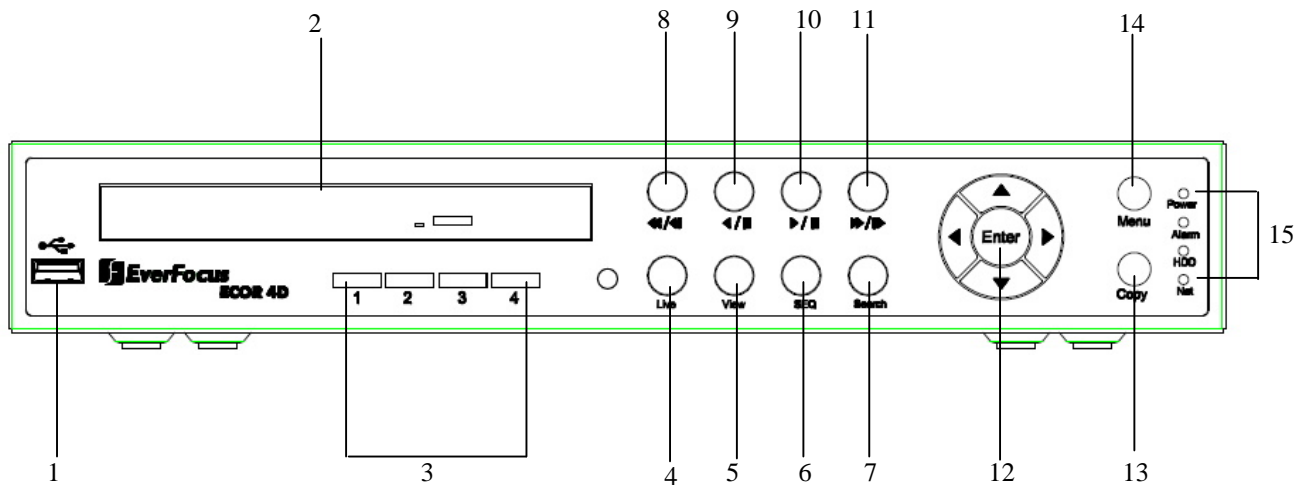

### 1. USB 2.0 (front)

For connecting USB mouse or USB flash memory.

### 2. DVD+RW Burner

DVD+RW burner (D models only)

### 3. Channel Key (1~4)/(1~8)

Press channel key (CH1~CH4) / (CH1~CH8) to display that channel in full screen view.

### 4. Live

Press this key to show live view. Press to exit from playback mode.

### 5. View

Press this key to switch between 4-screen, 9-screen, Picture In Picture, and Full-screen displays in live and playback mode.

Note1: PIP display is not available in playback mode.

Note2: 9-screen display available in 8 Channel model only

## 6. SEQ

Press this key to enter the auto sequential switching mode. The sequence dwell time can be set in "Display Setting" tab of the Menu. For more detail about SEQ, please see "5.8.2 Display Setting-Main M/T SEQ".

## 7. Search

Press this key to enter Search Menu. For more detail about Search function, please see "4.8 Search".

## 8. Fast reverse playback or step reverse playback depending on playback mode

## 9. Reverse playback or pause

## 10. Forward playback or pause

## 11. Fast Forward playback or step forward playback depending on playback mode

## 12. Enter and Arrow buttons

If you do not use a mouse, you can use these keys to change the Menu settings.

## 13. Copy

Press this key to enter Copy Menu. For more detail about Copy function, please see "4.7 Copy".

## 14. Menu

Press this key to enter/exit MAIN SETUP MENU.

## 15. System LEDs

LED displays for Power, Alarm, HDD and Net active.

## 1.5 Back Panel

During initial setup you will be connecting your DVR to multiple input and output devices. This is done through the back panel.

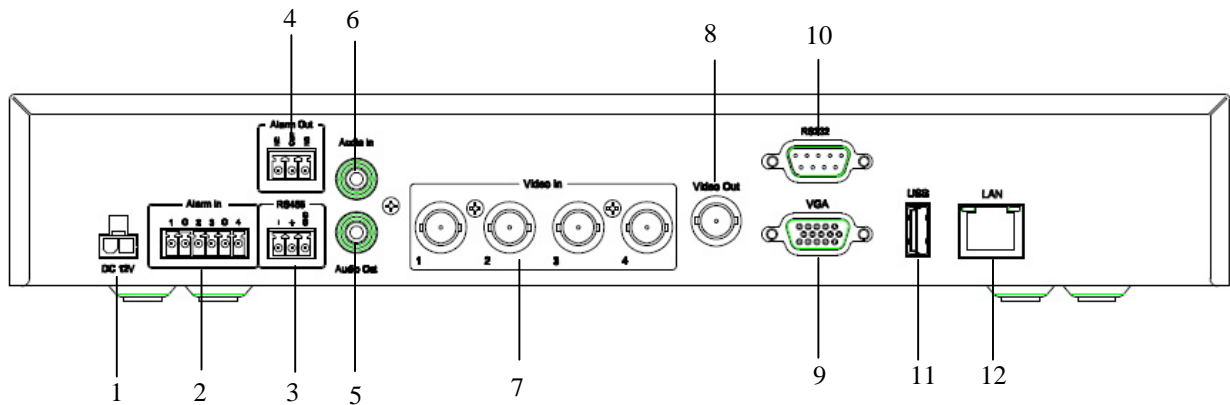

### 1. Power

Plug the DC 12V power source into the power socket.

### 2. Alarm In

Connect up to 4 / 8 alarm inputs, selectable between dry contact or TTL/CMOS signal polarity.

### 3. RS485

Terminal Connector for RS485 control.

### 4. Alarm Out

N.C or N.O type alarm signal out.

### 5. Audio Output

Connect a speaker or other audio listening devices to the audio output connection on the back of the digital video recorder.

### 6. Audio Input

Connect a microphone or camera audio output to the audio input connection.

7. Video In

Connect camera's video output or other composite video source to the video input connection.

8. Video Out

Connect a CCTV monitor to the video output connection.

9. VGA

Connect a VGA monitor to the VGA output connection.

10. RS232

For DVR serial command control

11. USB 2.0 (back)

USB port allows you to archive video files to USB flash memory device or to connect the mouse.

12. LAN

RJ-45 network connection

## 2 Installation

### 2.1 Video Connections

Camera and CCTV monitor must use 75 Ohm video cable (e.g. RG-59, RG-6, RG-11) with BNC connectors.

Due to inappropriate absorbability, 50 Ohm coax cable (e.g. RG-58), antenna cable and other types of coaxial cable are not compatible.

All connected video sources must provide a 1 Vpp NTSC or PAL standard video signal.

When converting transmission lines (twisted pair, fibre optics, radio) to the video inputs, be sure to verify accurate receiver calibration.

**ATTENTION:** In order for the system to auto-detect the appropriate video format (NTSC or PAL), make sure that there is a video signal on video input 1 upon power-up.

### 2.2 Audio Connection Installation

The ECOR DVR provides 1 audio input and 1 audio output.

The input is designed for max. 500 mV to 10 KOhm line audio signals.

**ATTENTION:** The direct connection of a non-amplified microphone is not supported (a microphone amplifier is required).

The installation must be done with audio coax cable and RCA plugs.

The output provides a max. 500 mV to 10 KOhm line audio signal and may be connected to a monitor's audio input. The direct connection of passive speakers is not supported.

#### AUDIO RECORDING FUNCTIONALITY:

Audio recording is activated / deactivated in the RECORD menu.

Audio channel is always recorded together with video and is independent of the image recording rate. There is no specific camera allocation.



## 2.3 Alarm Input / Output Installation

ECOR DVR provides 4 / 8 alarm inputs.

Inputs have to be switched through dry contacts. The output relays provide a dry N.O. / N.C. contact..

All settings are programmed in the ALARM menu.

Pin assignment:

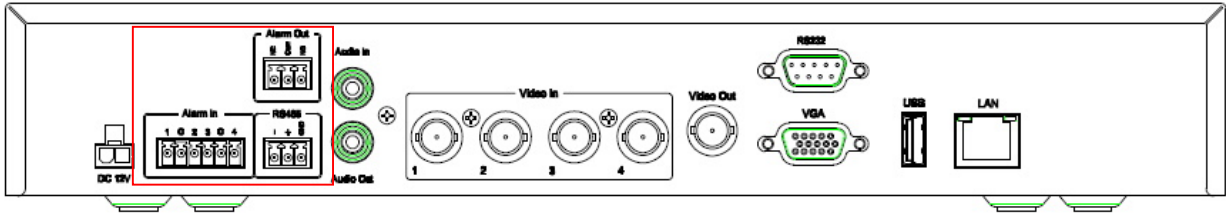

Group	PIN label	Description
Alarm in	1	Alarm input 1
	G	Common ground for alarm inputs
	2	Alarm input 2
	3	Alarm input 3
	G	Common ground for alarm inputs
Alarm out	NC	Output relay, N.C. contact
	COM	Output relay, common PIN
	NO	Output relay, N.O. contact
RS485	-	RS485- (A)
	+	RS485+ (B)
	GND	RS485 GND

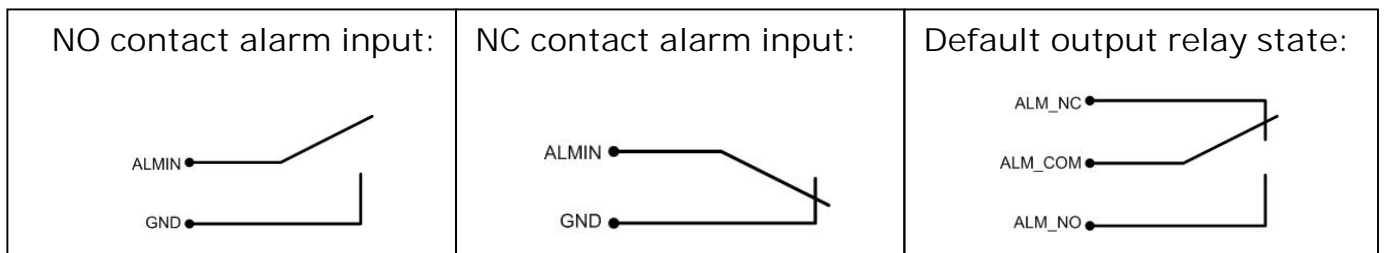

## 2.4 Network Connection

ECOR DVR provides fast MPEG-4 format image transmission and network remote configuration.

ATTENTION: A monitor is required for initial network configuration. For more information about network setup, please refer to Chapter 7.

Physically, two basic types of connection are possible:

### 2.4.1 Direct PC Connection through Crossover Network Cable

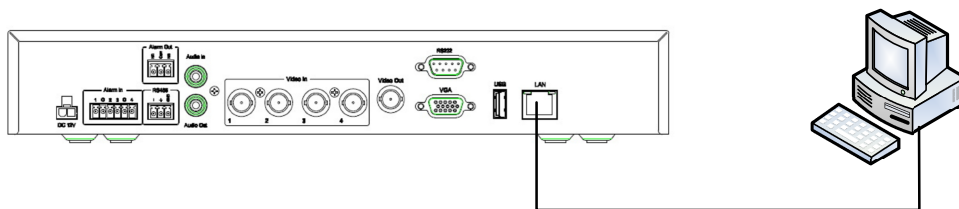

Figure 2.1

The point-to-point connection of DVR and PC requires a crossover (crossed) network cable. This type of connection is **ONLY** used for direct connection to a single PC.

Make sure that the PC is equipped with a 10/100/1000 Mb compatible network connection.

### 2.4.2 Network Connection through Patch Cable

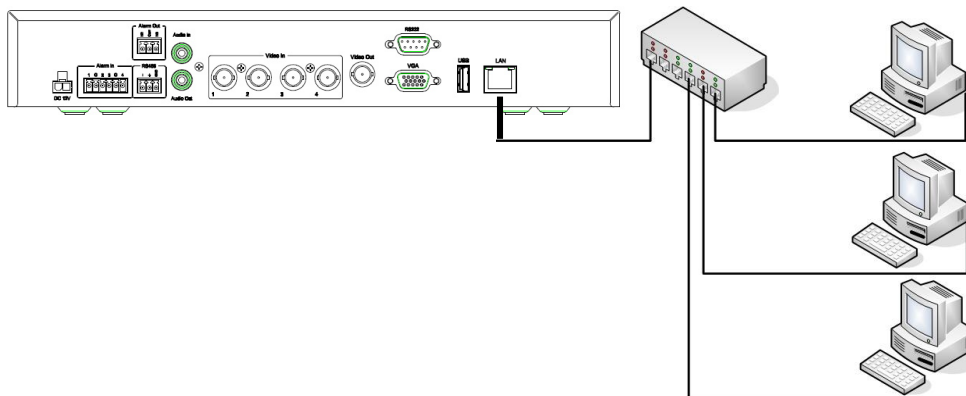

Figure 2.2

The connection to an existing network requires a normal patch cable (straight-through). The illustration shows the connection to a network switch, router, or modem.

### 2.4.3 Network System Requirements

Connection type: 100Base-T

Min recommended network bandwidth: 256 K

Max. required network bandwidth: 3 M

Protocol types used: TCP, UDP, SMTP, HTTP, NTP

Required ports: 80, 1600; for port information, please refer to "5.6, Network Setting".

## 2.5 Speed Dome Installation

Speed dome or pan/tilt/zoom control is available through web browser if the DVR is connected to a network. Local control is provided by the optional EKB 500 keyboard.

Supported protocols: EverFocus, Pelco-D, Pelco-P, Transparent, Samsung.

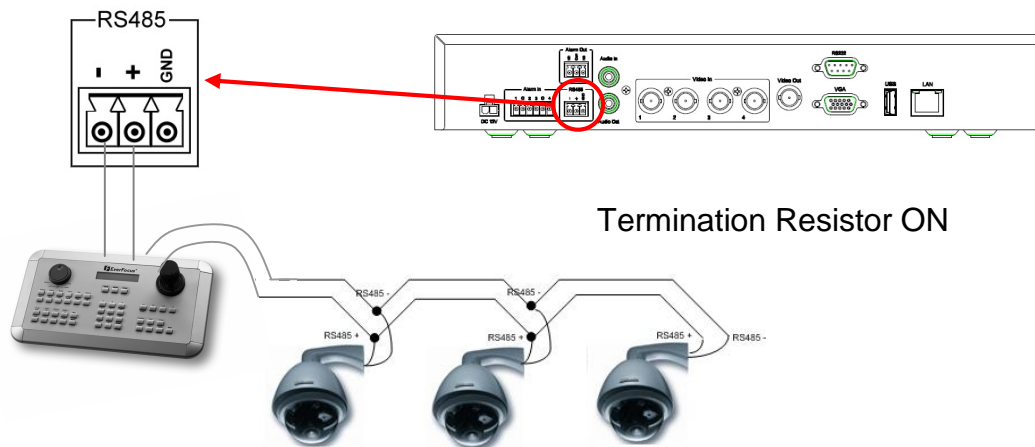

Figure 2.3

Sample installation with 3 EPTZ1000 speed domes and EKB500

Required DVR configuration: RS-485 receiver address in CAMERA menu; RS-485 parameters and protocol in I/O CONTROL menu

ATTENTION: Some Pelco-D / -P protocol domes and receivers may require an address offset of -1. In other words, the address in the DVR's Camera Menu must be 1 below the address set in the actual dome / receiver. (example: ID in Device = 3, ID in DVR = 2)

## 2.6 Final Install Process

Once you have completed the basic wiring connections, you are ready to turn on the DVR. Simply plug in the power source. The POWER LED will light up if power is normal. Once the system has finished loading, you can begin to set up the menu options for the DVR.

## 3 Mouse and Front Panel Operation

ECOR series DVR supports multiple sources to control the DVR. It can be controlled with a mouse, the front panel, an EKB500, the handheld remote control, or serial command from RS232 port.

This chapter will cover the basic operation using mouse and front panel.

### 3.1 General USB Mouse Operation

#### 3.1.1 OSD Root Menu

1. Right-click the mouse to obtain DVR control bar (see Figure 3.1). When you move the mouse over each icon, the appropriate title will be displayed on top of the control bar.



Figure 3.1

2. Click on any icon to perform that action. These actions are covered in detail in Chapter 4.
3. Click the "x" sign in the top-right corner to close the DVR control bar.

### 3.1.2 Operation in Configuration Menu

The Main menu (shown in Figure 3.2) is divided into 3 main sections.



Figure 3.2 (OSD Menu)

1 In section 1, there are twelve setup options available. Move the mouse over an icon to select it.

2 In section 2, the main options for the selected icon will be displayed. Click on a word to select it.

3 In section 3, all the details for the selected option will be available. Click on an option to make changes.

### 3.1.3 Component Options

The following are examples of different fields available in the Configuration menu.

**Password**  Textbox: Click on the box and an on-screen keyboard will appear below it. (For more details about on-screen keyboard, please see "\*\*Note about on-screen keyboard\*\*").

**Resolution** 704x240  Dropdown box: Click on the down arrow to see all selections, then directly click on an option to select it.

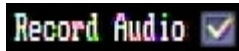

Check box: Click on the box to check or uncheck it. Checked will enable the function, unchecked will disable the function.



Button: Click the button to execute the function.



Selection box: Click Up/Down arrow to increase or decrease the value.



Bar: Click and hold on the bar to adjust the cursor Left or Right.

\* Note about on-screen keyboard:

Click on a button to input that character.

The buttons on the right and bottom have the following functions:



<- BS	Delete the previous letter
Delete	Delete the next letter
Clear	Clear box
Enter	Confirm the selection
Caps	Switch to capital letters
Space	Enter a space
<-	Move to left
->	Move to right
Cancel	Cancel and exit from the keyboard

## 3.2 General Front Panel Operation

### 3.2.1 Front Panel Key Review

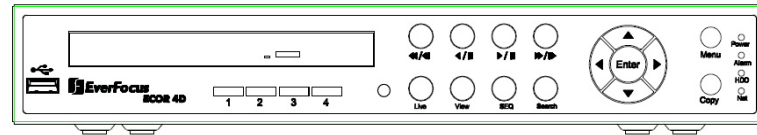

The basic principle of front panel operation is to use navigation keys (up, down, left and right) to navigate among the menu items. Use “Enter” key to confirm a selection or enter the next level menu. Press “Menu” key to enter the Main Menu or exit from the current level of the menu.

### 3.2.2 Operation in Configuration Menu

Press “Menu” button to enter the Main Menu.

NOTE: If password is active, you will need to log in first. Refer to “4.2 Login” for information on logging in. The menu (shown in Figure 3.3) is divided into 3 main sections.



Figure 3.3 (OSD Menu)

φ In section 1, there are twelve setup options available. Use the arrow keys to highlight an icon and press “Enter” to select it.

α In section 2, the main options for the selected icon will be displayed. Use the arrow keys to highlight an option and press “Enter” to select it.



⌚ In section 3, all the details for the selected option will be available here. Use the arrow keys to move between items and press “Enter” to make changes.

Note: press “Menu” button to go back to the previous menu section.

### 3.2.3 Component Options

**Password**  Textbox: Press Enter key and an on-screen keyboard will appear below. (For more details about on-screen keyboard, please see \*Note about on-screen keyboard).

**Resolution**  Dropdown box: Press “Enter” key to show the available options. Use the Up/Down arrow keys to highlight the desired option and press “Enter” again to select it.

**Record Audio**  Check box: Press “Enter” key to enable or disable the setting.

**Copy**  Button: Press “Enter” key to execute the function.

**Camera**  Selection box: Press “Enter” key to select the field, then use the Up/Down arrow keys to scroll through the desired options. Press “Enter” again to choose it.

**Brightness**  Bar: Press “Enter” key to activate the slider, then use the Left/Right arrow keys to adjust the setting. Press “Enter” again to finalize the changes.

\* Note about on-screen keyboard:

Use the arrow keys to highlight a button and press “Enter” to input that character.  
The buttons on the right and bottom have the following functions:



<- BS	Delete the previous letter
Delete	Delete the next letter
Clear	Clear box
Enter	Confirm the selection
Caps	Switch to capital letters
Space	Enter a space
<-	Move to left
->	Move to right
Cancel	Cancel and exit from the keyboard

## 4 General DVR Operations

This chapter introduces the operations on major functions including playback, layout change, sequence, triplex operations, archive, and search.

### 4.1 Record

By default, the ECOR series DVR will always be in record mode. When the DVR is turned on, it will start to record.

The exceptions are:

1. ECOR will not record any disabled cameras (Refer to section 5.3.1 for more detail)
2. If a schedule is active, ECOR will follow the record settings of the schedule.

### 4.2 Login

In order to access ECOR options, users will be asked to log in for authority identification. To log in, follow these steps.

1. Click on the Menu icon or press "Menu" button to bring up the following screen:

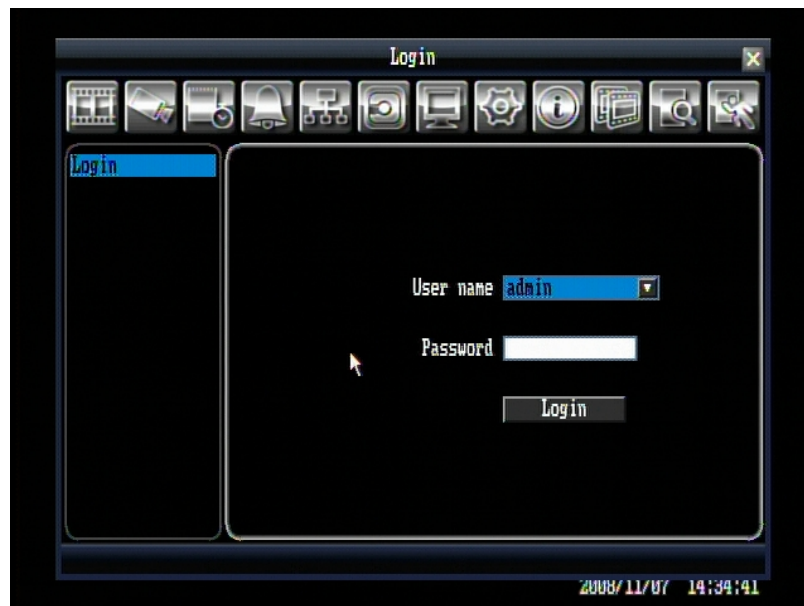

Figure 4.1 (Login page)

2. Input the desired user name and password. The defaults are:

User name: admin

Password: 11111111

+ To select a user name: click the drop down button to show the list of the users, then click the desired user from the list.

(Using front panel: press "Enter" key to show the drop-down list. Use "Up" and "Down" key to select the desired name, and press "Enter" key to confirm the selection.)

+ To input the password by mouse: click the password field to bring up the on-screen keyboard (see Figure 4.2). Click on each button to input the desired characters for the password. When finished, click "Enter" on the on-screen keyboard to confirm the password.

(Using front panel: press "Enter" key to show the on-screen keyboard. Use the arrow keys to highlight each character and press "Enter" key on front panel to input the selected characters. When finished, highlight "Enter" on the on-screen keyboard and press "Enter" key on front panel to confirm the password input.

+ Click (or press "Enter" key) on "Login" button to log in to the system.

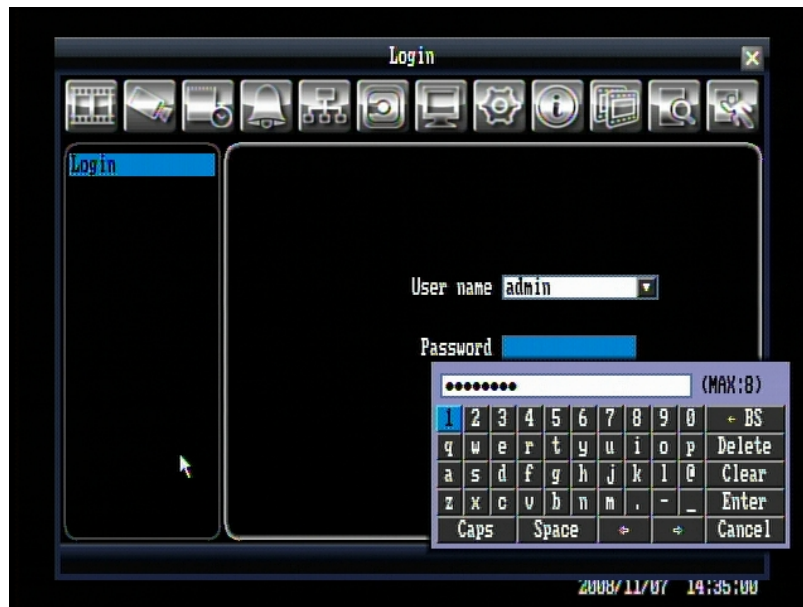

Figure 4.2 (on-screen keyboard)

3. If an invalid user name or password is used 5 times, the DVR will give an error message and automatically lockdown. No access will be granted for 10 minutes without the backdoor password. To obtain the backdoor password, you will need to contact EverFocus Technical Support and give the provided access code.

EverFocus Support by phone: 1-888-884-9154 (toll-free)

EverFocus Support email: [techsupport@everfocus.com](mailto:techsupport@everfocus.com)

## 4.3 Playback Operation

### 4.3.1 Playback

Mouse: Right-click while viewing cameras to bring up menu bar and click  to start playback.



Front panel: Press  button while viewing cameras to directly start playback.



### 4.3.2 Reverse playback

Mouse: Right-click while viewing cameras to bring up menu bar and click  to start rewind.

Front panel: Press  button while viewing cameras to directly start rewind.

### 4.3.3 Pause

Mouse: While in playback mode, right-click to bring up menu bar and click either  or  to pause the video.

Front panel: While in playback mode, press either  or  keys to pause the video.

### 4.3.4 Fast forward

Mouse: While in playback mode, right-click to bring up menu bar and click  to start fast forward. Click the button again to increase playback speed to higher level (2x, 4x, 8x, 16x, 32x, or max).

Front panel: While in playback mode, press  key to start fast forward. Press the key again to increase speed to higher level (2x, 4x, 8x, 16x, 32x, or max).

### 4.3.5 Fast backward

Mouse: While in playback mode, right-click to bring up menu bar and click  to start fast rewind. Click the button again to increase speed to higher level (2x, 4x, 8x, 16x, 32x, or max).

Front panel: While in playback mode, press  key to start fast rewind. Press the button again to increase speed to higher level (2x, 4x, 8x, 16x, 32x, or max).

### 4.3.6 Step forward

Mouse: While in pause mode, right-click to bring up menu bar and click  to step forward once.

Front panel: While in pause mode, press  key to step forward once.

### 4.3.7 Step backward

Mouse: While in pause mode, right-click to bring up menu bar and click  to step backward once.

Front panel: While in pause mode, press  key to step backward once.

### 4.3.8 Stop playback

Mouse: While in playback or pause mode, right-click to bring up menu bar and click  to go back to live mode.

Front panel: While in playback or pause mode, press  key to go back to live mode.

## 4.4 Start Sequence

In sequencing mode, DVR will show each channel in full screen based on the configuration. For more detail about sequence setting, please refer to "5.8.2 Main M/T SEQ".

Mouse: Right-click to bring up menu bar and click  to start sequence

Front panel: Press  key to start sequence.

## 4.5 Layout Change

### 4.5.1 Layout Change

The 4 CH ECOR DVR has a total of three display modes available, and the 8 CH ECOR has four. The different available layouts are shown below:

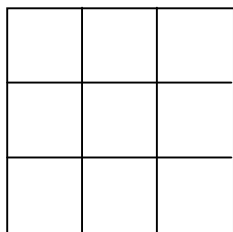

(9 screens)

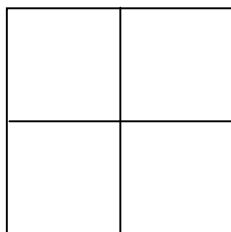

(4 screens)

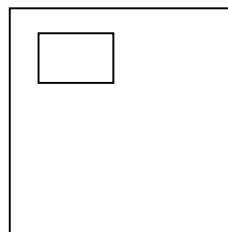

(PIP)



(Full)

To change layout, follow the steps below:

By mouse: Right-click to bring up the menu bar and click  to switch between 9, 4, PIP and full displays.

By front panel: Press  key to switch between 9, 4, PIP and full displays.

Notes ◊ 9 screen display is only available for 8 CH model

◊ PIP display is not available in Playback mode

### 4.5.2 Bring to Full Screen Mode

By mouse: Left-click on the selected channel to put that camera in full screen mode.

By front panel: Press any channel key to bring that channel to full screen mode.

## 4.6 Quick Menu

In 9/4 displays mode, use arrow keys to move between select different screens. Press the “Enter” key while selecting a screen to bring up a small quick menu (see Figure 4.3).

Note: This menu can only be accessed using the front panel.



Figure 4.3

### 4.6.1 Triplex Operation

Each camera can be individually set in either live mode or playback mode.

1. Use the mouse to select “Live” or “Playback” mode. You can also use the arrow keys and press the “Enter” key to confirm.
2. Once the selection is made, click on the “OK” button with the mouse or highlight “OK” using the arrow keys and press “Enter” key to confirm.
3. If you wish to cancel the selection and exit from the quick menu, click on the “Cancel” button with the mouse, or highlight “Cancel” using the arrow keys and press the “Enter” key to confirm.

### 4.6.2 Change Camera Order

Cameras can be manually rearranged into a different display order.

1. Click or press the “Enter” key on the drop-down menu to bring up a list of cameras.
2. Click or press the “Enter” key on the desired camera.
3. Click on the “OK” button (or highlight it and press the “Enter” key) to display the camera on the selected screen.

## 4.7 Copy

To bring up Copy menu:

By mouse: Right-click to bring up the menu bar and click on  to enter Copy Setup Menu.

By front panel: Press  key to enter Copy Setup Menu.



Figure 4.4 (Copy Menu – Standard Copy)

### 4.7.1 Standard Copy

Camera: Select which cameras will be copied.

Include Player: Check the box to include the ePlayer file as part of the copy.

Start Date/Time: Select the starting date/time to be copied.

End Date/Time: Select the ending date/time to be copied.

Archive To: Select whether you want to copy to USB or DVD.

Data Size: Total size for the time period that you have selected for archiving.

Copy Now: Press button to start copying.

USB/DVD (Size): This shows how much space is available on the chosen media.



## 4.7.2 Quick Copy



Figure 4.5 (Copy Menu – Quick Copy)

Select Auto Copy Logic:

Copy Content: Select content to be copied.

“Alarm only” will copy only Alarm events within the selected time.

“All” will copy all video within the selected time.

Copy Time From: Select how far back you wish to copy from the drop-down list.

Write Auto Copy Logic:

To USB Drive: Press button to Copy video file to USB.

## 4.8 Search

By mouse: Right-click to bring up the menu bar and click  to enter Search Menu.

By front panel: Press  key to enter Search Menu.



Figure 4.6 (Search Menu – Time Search)

#### 4.8.1 Time Search

Play From: Select the time period to be searched by choosing the Date and Time.

Click on the “Search” button to start search. The DVR will automatically play the video being searched.

#### 4.8.2 Event Search



Figure 4.7 (Search Menu – Event Search)

From: Select starting date and time

To: Select ending date and time.

Camera: Select which cameras to search for.

Event: Select which event type(s) to search for. Choose from Alarm, Motion, Video Loss, or System Event.

Click on the "Search" button to start searching. The search results will be shown as a list of events, explained in section 4.8.4.

### 4.8.3 Smart Motion Search

In order to perform a Motion Search, motion must be enabled first (see "5.3.3 Camera Setting – Motion").



Figure 4.8 (Search Menu – Motion Search)

From: Select motion search starting date/time.

To: Select motion search ending date/time.

Camera: Select camera number to be searched.

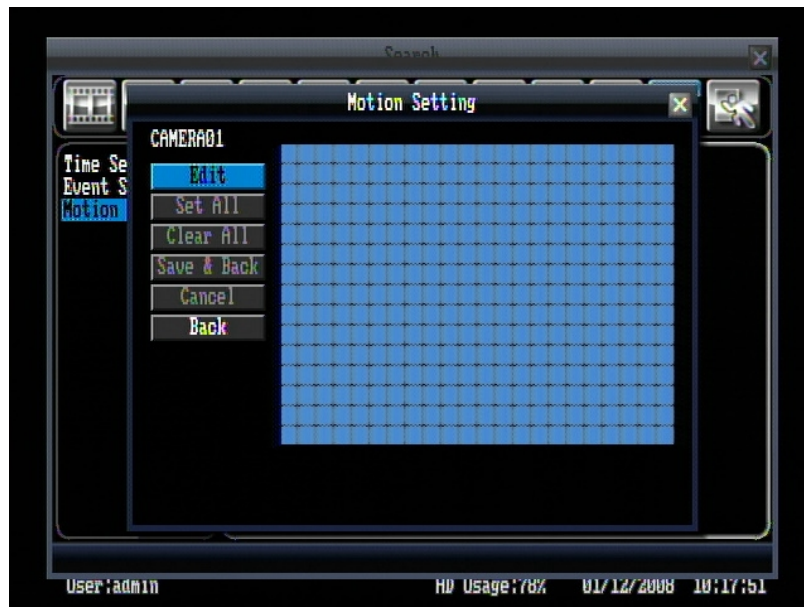

Figure 4.9 (Search Menu – Set Grid)

#### Set Grid:

Choose which areas of the motion grid will be included in the search. The areas you set in motion search must also be active in the motion settings of the Camera Setting Menu. Press "Edit" button to start editing motion grid. Use the mouse to drag your desired area. Press "Set All" button to select the entire area. Press "Clear All" to deselect the entire area. Press "Save & Back" to save the motion grid setting and go back to Motion Search menu. Press "Cancel" to cancel motion grid editing. Press "Back" to return to Motion Search menu. (See Figure 4.9)

Press "Search" button to start searching.

#### 4.8.4 Search Result

Time search will jump directly to the specified time and begin playing back.

Event search and motion search are displayed as an event list, shown in Figure 4.10.



Figure 4.10 (Search Menu – Event List)

: Go to the first page of event list.

: Go to the previous page of event list.

: Go to the next page of event list.

: Go to the last page of event list.

Click on any event to highlight it.

Date/Time: Check the box to show date and time in the list.

ID: Check the box to show event ID in the list.

Press "Play" button to playback the selected event.

## 4.9 Logout

Figure 4.11 is a screen shot of the LOGOUT SETTING MENU.

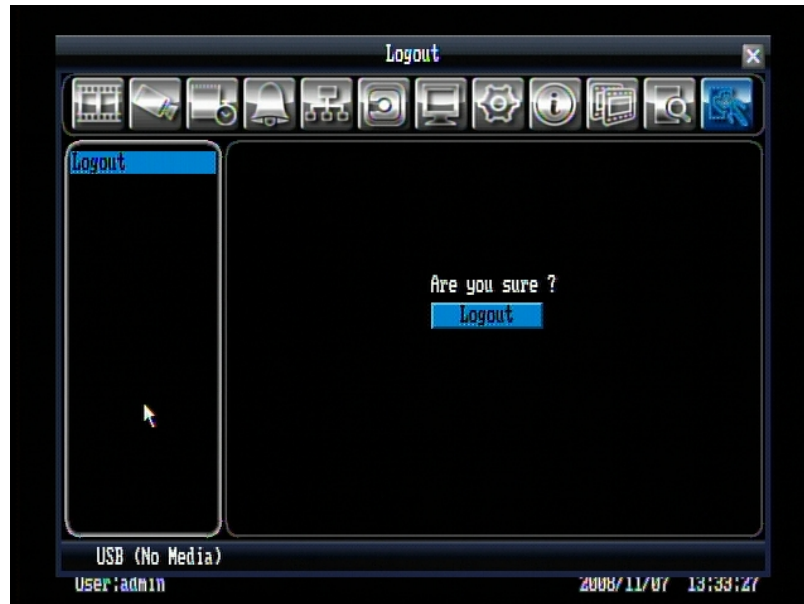



Figure 4.11 (Logout Menu)

Press "Logout" button when you are ready to logout from the system. You will need to login again before accessing any other options.

## 5 DVR Configuration

This chapter will walk you through the DVR Menu Settings step by step and show you how to set the DVR for your specific application.

### 5.1 OSD Setting Menu

To bring up the Main Menu, right-click with the mouse to bring up the menu bar and click the  button. You can also press the "Menu" key on the front panel.

Note: You will have to log in to access the Main Menu. Please refer to 4.2 for login information

### 5.2 Record & Play Setting

Figure 5.1 is a screen shot of the RECORD & PLAY SETTING MENU. This menu is used to configure basic recording and playback settings.

#### 5.2.1 Record



Figure 5.1 (Record & Play Menu)

Record Audio: Check the box to record audio.

Resolution: Select recording resolution based on video format

NTSC: 704x480 / 704x240 / 352x240

PAL: 704x576 / 704x288 / 352x288

Time Stamp: Select if the time and date will display while recording. Choose from Top, Bottom, or Off.

Record Overwrite: Check the box and disk will begin overwriting when full.

Auto Erase Video: The hard drive will automatically erase after the selected number of days. Select "Off" to disable this function.

Pre-alarm Recording: Check the box to enable pre-alarm recording function.

## 5.2.2 Play



Figure 5.2 (Record & Play Menu - Play)

Quick Playback: Check the box to enable quick playback function.

Playback From X Seconds ago: When the DVR is put into playback, it will begin playing automatically from the selected time. Choose from 60 to 3600 seconds (1 – 60 minutes).



## 5.3 Camera Setting

Figure 5.3 is a screen shot of the CAMERA SETTING MENU. This menu is used to configure individual camera settings.



Figure 5.3 (Camera Menu-Basic Setting)

### 5.3.1 Basic Setting

Camera: Select the camera number.

Title: The title setting allows you to assign a title to each camera input. Each channel supports a title with up to 16 characters. The on-screen keyboard will appear when you click the title option.

Install: Check the box to enable the current camera. To take full advantage of the DVR's recording abilities, any unused cameras should have this option disabled.

Record Mode: 2 record modes are available to be chosen.

Continuous: Constant recording.

Event: Video will be recorded only when events occur.

Covert: Check the box to hide a channel screen in live and sequence modes. However, the image will still be recorded and can be played back by any user who has playback rights.

Record Quality: Select an image quality for recording. There are five different qualities available: Superior, High, Standard, Basic and Low. A higher image quality uses more HDD space.

Normal Speed: Record speed for continuous recording. The speed is limited to the maximum recording rate of the DVR (displayed in the bottom left corner) divided by the number of installed cameras.

Event Speed: Record speed for event recording. Event record speed can be set from 1 to 30 (25 for PAL).

PTZ ID: Set PTZ ID from 001~127 or OFF (OFF is the same as 000). This ID must match the ID used by the PTZ camera in order to control the camera.

Copy: Press "Copy" button to copy the settings to other cameras. This will bring up the copy window shown in Figure 5.4. Check the boxes for each camera you wish to copy to, then click "OK" to copy settings. Click "Select All" to choose all cameras. Click "Cancel" to cancel copy.



Figure 5.4 (Camera Menu – Camera Copy)

### 5.3.2 Video Adjust

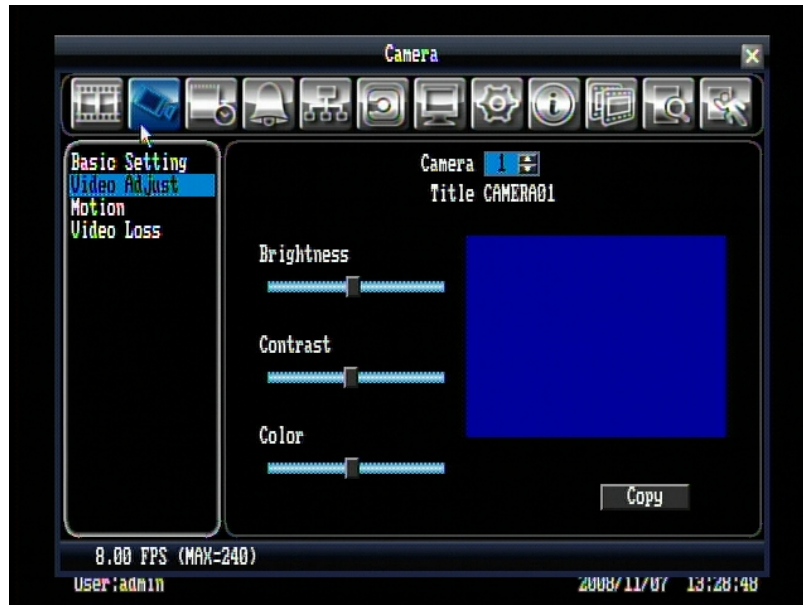

Figure 5.5 (Camera Menu – Video Adjust)

Camera: Select the camera you wish to adjust. "Title" will change to the name of the selected camera.

Brightness: Adjusts how bright/dark the picture appears. If details appear to be lost in the shadows or darker regions, try increasing the Brightness. If the image appears too saturated or if the colors appear overwhelmed by glare, try decreasing the Brightness.

Contrast: Adjusts the total amount of light output from the display. If details are lost or lines appear distorted, try decreasing the contrast.

Color: Adjusts the amount of color information in the picture.

Copy: Press "Copy" button to copy the settings to other camera. This will bring up the copy window. Check the boxes for each camera you wish to copy to, then click "OK" to copy settings. Click "Select All" to choose all cameras. Click "Cancel" to cancel copy.

### 5.3.3 Motion



Figure 5.6 (Camera Menu – Motion)

Camera: Select the camera you wish to adjust. "Title" will change to the title name of the selected camera.

Enable: Check box to enable motion detection. Other motion options will not be available unless this feature is selected.

Log: Check box to record motion events in the log.

Sensitivity: Allows users to adjust motion detection sensitivity. Level 10 is the lowest setting, and level 1 is the highest. The default is level 5.

Alarm output: This will transmit a signal to another device. It can be set to either "NONE" (not activated) or "1" (output signal 1 transmits).

Output Type: Output action when alarm is triggered.

Timeout: Alarm output lasts for the set time duration.

Permanent: Alarm will remain on until user presses "Live" key on front panel.

Timeout Dur: Time duration selectable from 0 to 150 seconds.

Buzzer: Check box to enable buzzer when a motion event is detected.

Email Notify: Check box to send email notification function when a motion event is detected.

### Set Grid:

Press "Edit" button to start editing motion grid. Click and drag the mouse to select specific areas. Press "Set All" button to select the entire area. Press "Clear All" to clear all the grids selected. Press "Save & Back" to save the motion grid setting and go back to motion setting menu. Press "Cancel" to cancel motion grid editing. Press "Back" to return to motion setting menu (See Figure 5.7).



Figure 5.7 (Camera Menu – Motion Setting)

**Main Monitor:** Monitor display options when a motion occurs.

No change: No change on the main monitor display.

Full screen: A full screen of the active camera will display.

**Copy:** Press "Copy" button to copy the settings to other camera. This will bring up the copy window. Check the boxes for each camera you wish to copy to, then click "OK" to copy settings. Click "Select All" to choose all cameras. Click "Cancel" to cancel copy.

### 5.3.4 Video Loss

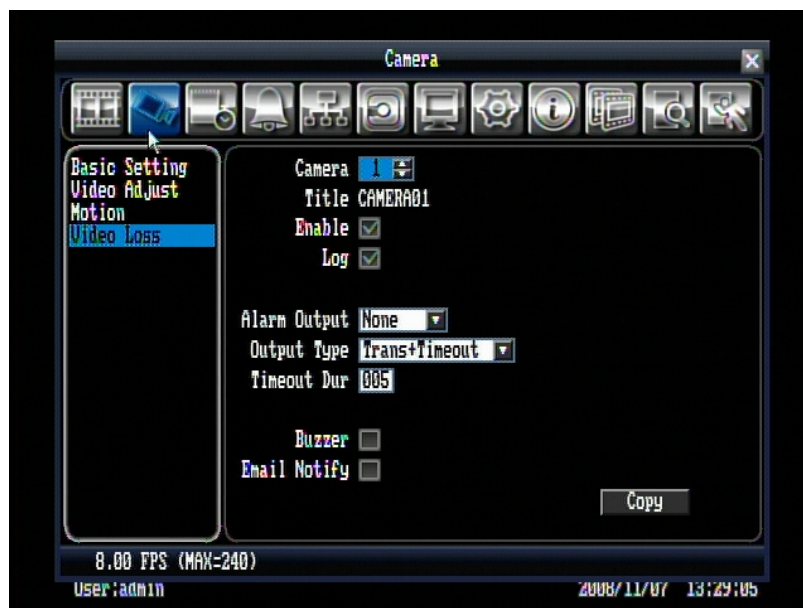

Figure 5.8 (Camera Menu – Video Loss)

Camera: Select the camera you wish to adjust, "Title" will change to the title name of the selected camera.

Enable: Check box to enable Video Loss.

Log: Check box to record video loss events in the log.

Alarm Output: This will transmit a signal to another device. It can be set to either "NONE" (not activated) or "1" (output signal 1 transmits).

Output Type: Output action when alarm is triggered.

Timeout: Alarm output lasts for the set time duration.

Permanent: Alarm will continuously work until user presses "Live" key.

Transparent: Alarm output continues as long as there is a video loss.

Trans+Timeout: Alarm output continues until event ends, then lasts for the set time duration.

Timeout Dur: Time duration selectable from 0 to 150 seconds.

Buzzer: Check box to enable buzzer when a video loss event occurs.

Email Notify: Check box to enable email notification function when a video loss event occurs.

Copy: Press Copy key to copy the settings to other camera. This will bring up the copy window. Check the boxes for each camera you wish to copy to, then click "OK" to copy settings. Click "Select All" to choose all cameras. Click "Cancel" to cancel copy.

## 5.4 Schedule Setting

Figure 5.9 is a screen shot of the SCHEDULE SETTING MENU. In this menu you can set a unique timer to start recording during a specified time period.



Figure 5.9 (Schedule Menu)

First select one of the 10 available schedules from the left.

Enable: Check the box to enable the scheduled time period.

Day(s): This field represents the day of the week you wish to set the timer record for. You may choose from Monday through Sunday, as well as weekday, weekend, and daily.

Monday, Tuesday, Wednesday, Thursday, Friday, Saturday, Sunday

Weekday: from Monday to Friday.

Weekend: Saturday and Sunday.

Daily: every day of the week.

From: This field is used to set the time you wish to start the timer recording. Click on it to obtain the time setup menu (Figure 5.10). Click on the arrows to change hour and minute, then click "OK" to confirm or "Cancel" to quit.

To: This field is used to set the time you wish to stop the timer recording. Click on it to obtain the time setup menu (Figure 5.10). Click on the arrows to change hour and minute, then click "OK" to confirm or "Cancel" to quit.

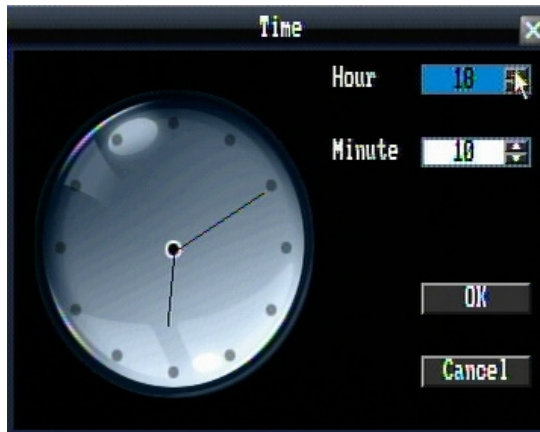

Figure 5.10 (Time Setup Menu)

Normal: Constant IPS recording rate for the selected schedule. The maximum image rate is limited to the maximum recording rate (displayed in the bottom-left corner) divided by the number of active cameras.

Event: IPS recording rate for events. Event record speed can be set from 1 to 30 IPS (25 for PAL).

Record Mode: Choose whether the selected camera records Continuously or only during Events on the current schedule.

Motion: Check the box to enable motion on the selected camera for the current schedule.

Schedule Summary: In schedule summary, you will see the status, start time, end time, and active day(s) of each schedule (See Figure 5.11).



Figure 5.11 (Schedule Summary)



## 5.5 Alarm & Event Setting

Figure 5.12 is a screen shot of the ALARM & EVENT SETTING MENU. This menu will walk you through alarm and event setup.



Figure 5.12 (Alarm & Event Menu - Alarm)

### 5.5.1 Alarm

Alarm: Select the alarm number.

Enable: Check box to enable alarm.

Log: Check box to record alarm events in the log.

Input Type: This field is to change the type of alarm trigger.

N.O.: Normal Open contact.

N.C.: Normal Close contact.

Name: Assign a name for the alarm input.

Active Camera: This field is for assigning the alarm to a specific camera. For example if you had an external motion detector on camera one you would set this option to "1".

PTZ Preset: Select PTZ Preset from "0" to "255". If the Active Camera is a PTZ speed dome, the alarm will move the camera to a preset position for event recording. This function can improve surveillance quality of an alarm event.

Alarm Output: This will transmit a signal to another device. It can be set to either "NONE" (not activated) or "1" (output signal 1 transmits).

Output Type: Output action when alarm is triggered.

Timeout: Alarm output lasts for the set time duration.

Permanent: Alarm will continuously work until user presses Live key.

Transparent: Alarm output keeps working according to the signal of alarm input.

Trans+Timeout: Alarm output continues until event ends, then lasts for the set time duration.

Timeout Dur: Timeout duration selectable from 1 to 150 seconds.

Main Monitor: Display options on main monitor when an alarm occurs.

No Change: No change on the main monitor display.

Full Screen: A full screen of the active camera will display.

Buzzer: Check box to enable buzzer when an alarm occurs.

Email Notify: Check box to enable email notification function when an alarm occurs.

Copy: Press "Copy" button to copy the settings to other camera. This will bring up the copy window. Check the boxes for each camera you wish to copy to, then click "OK" to copy settings. Click "Select All" to choose all cameras. Click "Cancel" to cancel copy.

### 5.5.2 Event

This option covers internal system event warnings.

Event: Select from the following event types.

Fan Failure: Cooling fan stops working

HD Temperature: Hard drive is over the safety warning temperature

HD Failure: Hard drive not detected

HD Full: Hard drive reaches maximum capacity (by default, the DVR will begin overwriting the HD)

## Fan Failure:



Figure 5.13 (Alarm & Event Menu – Event-Fan Failure)

Log: Check box to record events in the log.

Buzzer: Check box to enable buzzer when a fan fails to work.

Alarm Output: This will transmit a signal to another device. It can be set to either "NONE" (not activated) or "1" (output signal 1 transmits).

Email Notify: Check box to enable email notification function when a fan fails to work.

## HD Temperature:



Figure 5.14 (Alarm & Event Menu – Event - HD Temperature)

Log: Check box to record events in the log.

Buzzer: Check box to enable buzzer when hard drive's temperature is over the "Temp. Warning Limit".

Temp. Warning Limit: Sets the trigger temperature for all other active settings in HD Temperature. Choose from 55°C /131°F, 60°C /140°F, or 65°C /149°F.

Alarm Output: This will transmit a signal to another device. It can be set to either "NONE" (not activated) or "1" (output signal 1 transmits).

Stop Recording: Check box to stop recording when HD's temperature is over the "Temp. Warning Limit".

Email Notify: Check box to enable email notification function when HD's temperature is over the "Temp. Warning Limit".

HD Failure:

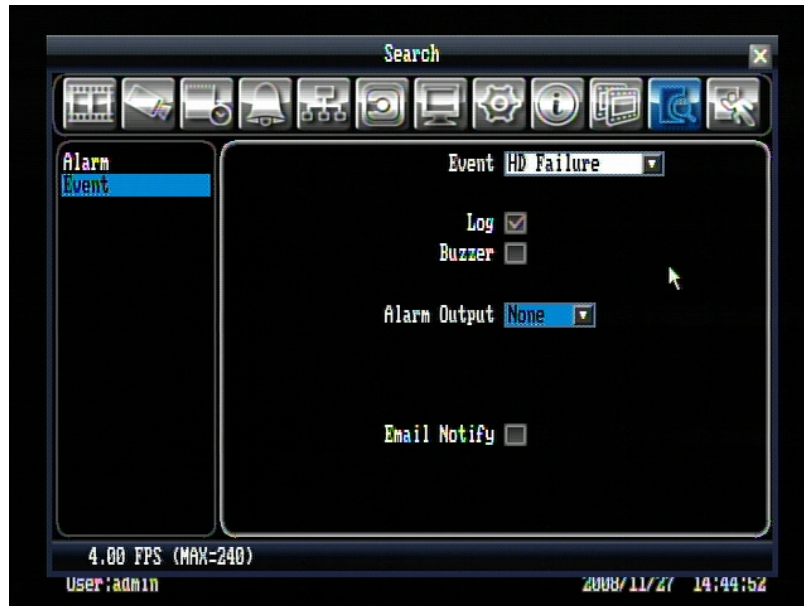

Figure 5.15 (Alarm & Event Menu – Event - HD Failure)

Log: Check box to record events in the log.

Buzzer: Check box to enable buzzer when no hard drive is detected.

Alarm Output: This will transmit a signal to another device. It can be set to either "NONE" (not activated) or "1" (output signal 1 transmits).

Email Notify: Check box to enable email notification function when HD fails.

## HD Full:

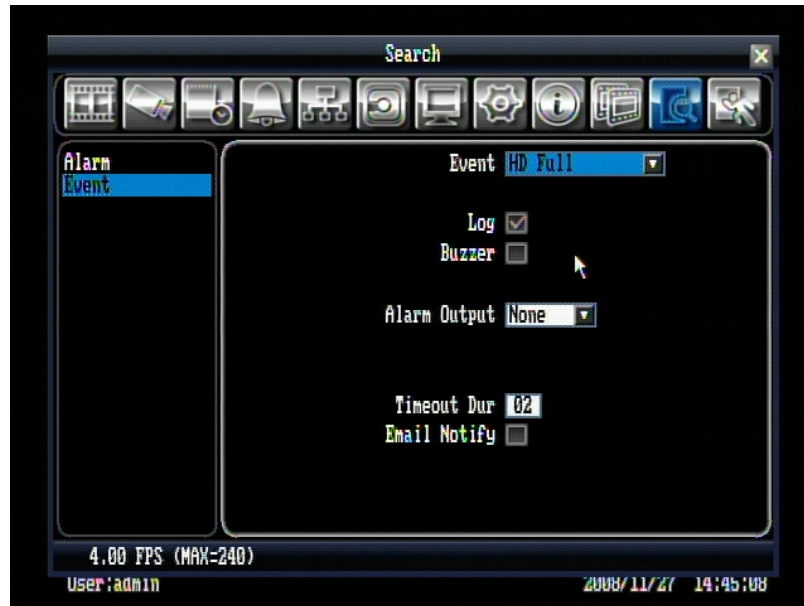

Figure 5.16 (Alarm & Event Menu – Event - HD Full)

Log: Check box to record events in the log.

Buzzer: Check box to enable buzzer when hard drive is full.

Alarm Output: This will transmit a signal to another device. It can be set to either "NONE" (not activated) or "1" (output signal 1 transmits).

Timeout Dur: The amount of time the buzzer sounds when the HD is full. Duration selectable from 1 to 99 seconds.

Email Notify: Check box to enable email notification function when HD is full.

## 5.6 Network Setting

Figure 5.17 is a screen shot of the NETWORK SETTING MENU. This menu is for setting up the configurations for networking to the DVR. There are 3 subentries in the NETWORK SETTING MENU: LAN, EMAIL and DDNS.

Note: Since every Network Configuration is different, please check with your Network Administrator or ISP to see if your DVR requires specific IP addresses and/or port numbers.

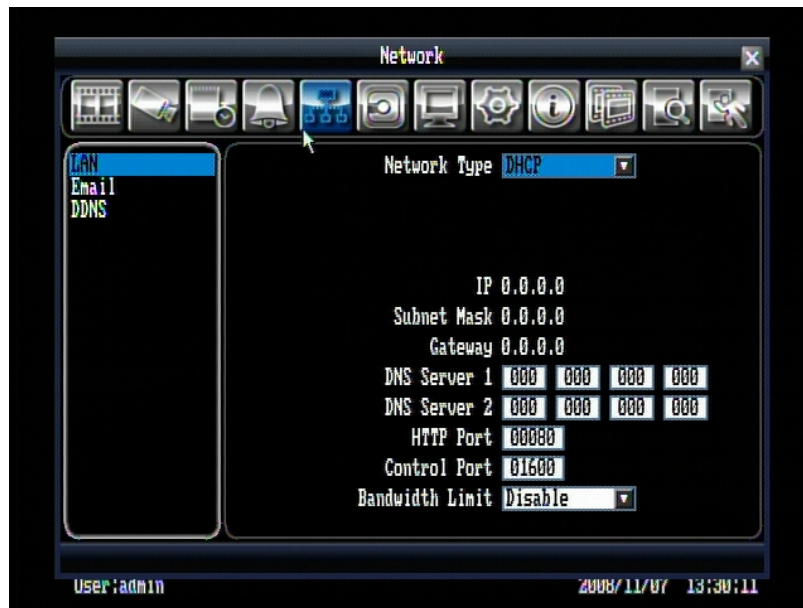

Figure 5.17 (Network Menu – LAN)

### 5.6.1 LAN

Network Type:

Static IP: User can set a fixed IP for network connection.

DHCP: DHCP server in LAN will automatically assign IP for network connection

PPPoE: This is a DSL connection application ONLY. Check with your ISP if they use PPPoE.

User Name: User name that is provided by ISP (only shows up when PPPoE is selected)

Password: Password that is provided by ISP (only appears when PPPoE is selected)

IP: This field shows the current IP Address for the DVR. A static IP address must be set manually. If DHCP or PPPoE is selected, this value will be assigned automatically (it cannot be changed manually).

Subnet Mask: This field shows the subnet mask for your network so the DVR will be recognized within the network. If DHCP or PPPoE is selected, this value will be assigned automatically.

Gateway: This field shows the gateway for your network so the DVR will be recognized within the network. If DHCP or PPPoE is selected, this value will be assigned automatically.

DNS Server 1: This field shows the primary DNS server for your network. When DHCP is selected and an internet connection is available, this value will be assigned automatically. This field must be assigned correctly if you plan to use the DDNS feature (see 5.6.3 for more detail).

DNS Server 2: This field shows the secondary DNS server for your network.

Note: The default addresses in the machine are for internal testing only. You must apply your own addresses to comply with your network. Refer to Chapter 8 for more details.

HTTP Port: Port number for HTTP/WEB communication.

Control Port: Port number for controlling authentication on Network Viewer.

Bandwidth Limit: Allows user to limit the bandwidth used by the DVR.

## 5.6.2 EMAIL

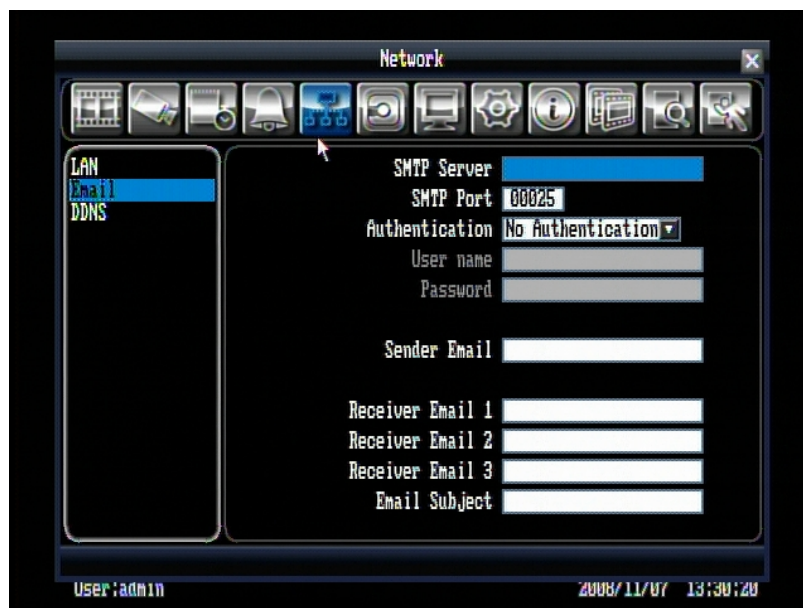

Figure 5.18 (Network Menu – Email)

SMTP Server: Assign the SMTP (e-mail) server's name.

Note: For more reliable email service, use the server's IP address.

SMTP Port: Assign the port number used by the SMTP server.

Authentication:

Authentication: The SMTP server requires an authentication (user name / password).

No Authentication: The SMTP server does not require authentication (user name / password).



User name: Input the login user name if the SMTP server requires authentication.

Password: Input the password if the SMTP server requires authentication.

Sender Email: Input sender's e-mail address.

Receiver Email 1: Input the first e-mail address that event messages are sent to.

Receiver Email 2: Input the second e-mail address that event messages are sent to.

Receiver Email 3: Input the third e-mail address that event messages are sent to.

Email Subject: Input email subject.

### 5.6.3 DDNS

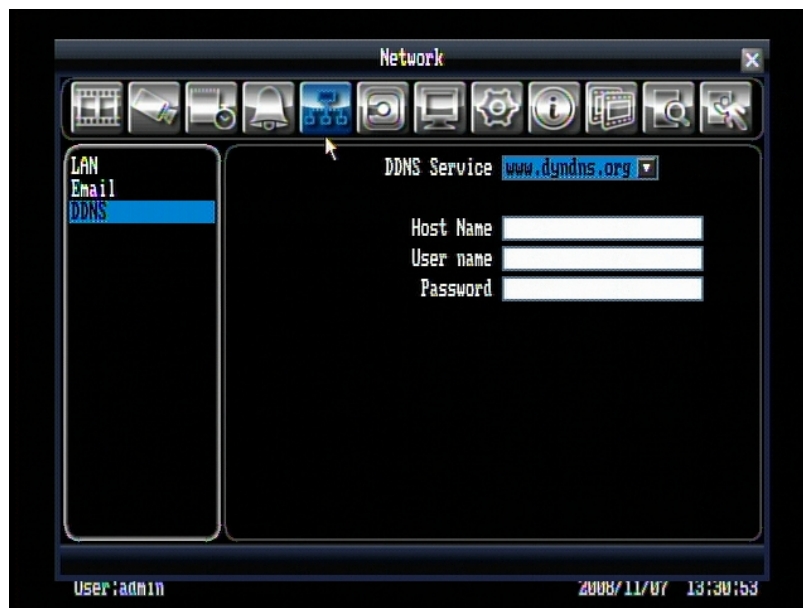

Figure 5.19 (Network Menu – DDNS)

DDNS Server: Select either “EverfocusDDNS” or “www.dyndns.org” as the DDNS provider. If DDNS will not be used, simply select “Disable”.

Host name: Host name of the account (dyndns.org only).

User name: User name of the account (dyndns.org only).

Password: Password of the account (dyndns.org only).

DVR Name: Name you wish to use for the DVR (EverfocusDDNS only).

Click on “Submit/Update” to update the chosen name on the server (EverfocusDDNS only).

Note: For more details on DDNS setup, please see “Chapter 7 - Everfocus DDNS Setup”.

## 5.7 Disk Setting

Figure 5.20 is a screen shot of the DISK SETTING MENU. This menu will walk you through disk settings.

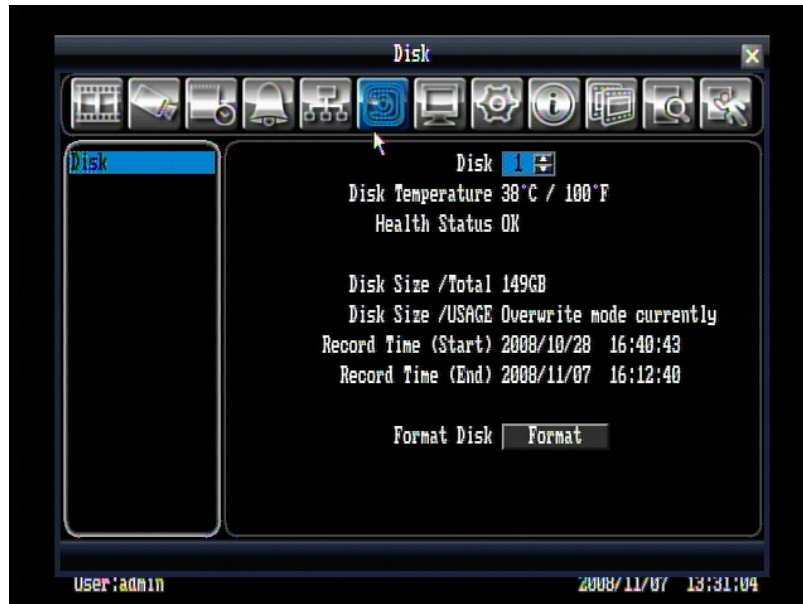

Figure 5.20 (Disk Menu)

Disk: Select the disk number.

Disk Temperature: Indicates current disk temperature.

Health Status: Indicates current health status of the disk.

Disk Size/Total: Shows total disk size available.

Disk Size/Usage: Shows percentage of used disk space. If DVR is set to automatically overwrite the disk, this option will show "Overwrite mode currently".

Record Time (Start): Shows earliest recorded time on the hard drive.

Record Time (End): Shows latest or most current recorded time on the hard drive.

Format Disk: Press "Format" button to format the disk. NOTE: This will erase all information on the disk.

## 5.8 Display Setting

Figure 5.21 is a screen shot of the DISPLAY SETTING MENU. This menu will walk you through Monitor On-Screen Display (OSD) and Main Monitor Sequential setup.



Figure 5.21 (Display Menu – Monitor OSD)

### 5.8.1 Monitor OSD

These are the display options for the Main Monitor.

Camera Title: Check the box to display camera titles.

Date/Time: Check the box to display current date/time.

Playback Date/Time: Check the box to display playback date/time.

Playback Status: Check the box to display playback status.

Event Status: Check the box to display event status.

HDD Status: Check the box to display hard drive status.

Text Insert: Check the box to display data transmitted from external RS232 device.

Main Monitor Type: The DVR supports both VGA and BNC outputs, but only one can have optimized display quality. Use this option to choose which output is optimized.

### 5.8.2 Main M/T SEQ

This menu is used to setup the sequence order and dwell time on the main monitor.

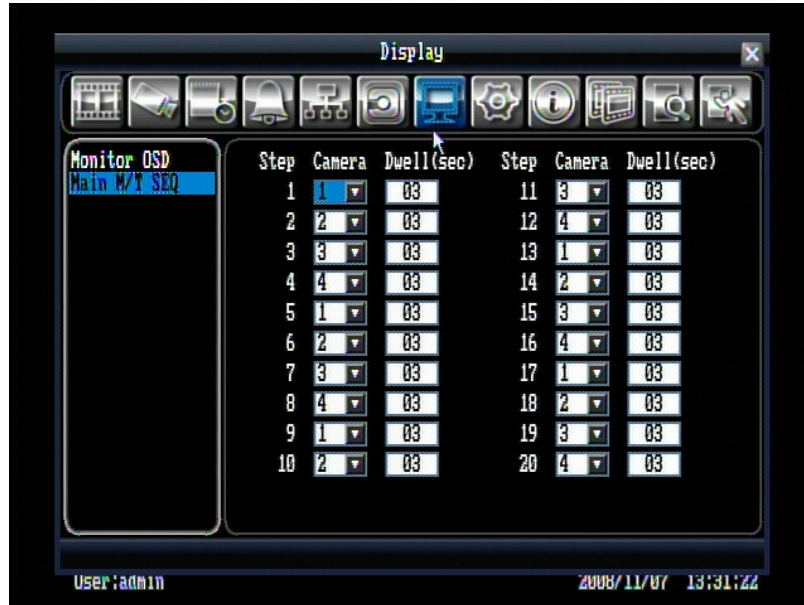

Figure 5.22 (Display Menu – Main M/T SEQ)

Step: Sequence order. Cannot be changed.

Camera: Select camera number that appears on the current step.

Dwell (sec): Set the dwell time for each step. Sequence dwell time can be set from 0 to 99 seconds.

## 5.9 System Setting

Figure 5.23 is a screen shot of the SYSTEM SETTING MENU. This menu is for setting up the system configurations of the DVR. There are 6 subentries in the SYSTEM SETTING MENU: Date/Time, Daylight Saving, User, Security, I/O Control and Firmware & Misc.



Figure 5.23 (System Menu – Date/Time)

### 5.9.1 Date/Time

**Time Zone:** You can set the time zone that the DVR adjusts to when updating from the time server.

**Date:** Set current Date.

**Time:** Set current Time.

**Date Format:** Choose date format from yyyy/mm/dd, dd/mm/yyyy, and mm/dd/yyyy.

**Time Format:** Change time format between 12H and 24H mode.

**NTP Update Interval:** The frequency that the system updates the correct time automatically when network is connected. Select either Off, Daily, Weekly, or Monthly.

**NTP Server:** You can set the time server address that the DVR connects to for time synchronize. To find a compatible NTP address, please follow these steps:

- a) Go to a PC that is connected to the internet.
- b) Click on "START" -> "RUN" -> type "command" and press "OK".
- c) In the DOS Prompt, type "ping pool.ntp.org" to find out the IP address of an NTP Server.

```
Command Prompt

C:\>ping pool.ntp.org

Pinging pool.ntp.org [209.126.142.251] with 32 bytes of data:

Reply from 209.126.142.251: bytes=32 time=203ms TTL=47
Reply from 209.126.142.251: bytes=32 time=203ms TTL=47
Reply from 209.126.142.251: bytes=32 time=203ms TTL=47
Reply from 209.126.142.251: bytes=32 time=203ms TTL=47

Ping statistics for 209.126.142.251:
    Packets: Sent = 4, Received = 4, Lost = 0 (0% loss),
    Approximate round trip times in milli-seconds:
        Minimum = 203ms, Maximum = 203ms, Average = 203ms

C:\>_
```

### 5.9.2 Daylight Saving



Figure 5.24 (System Menu – Daylight Saving)

Daylight Saving: Check the box to enable daylight saving time.

Start Date: Set the start date of daylight saving time.

Start Time (hh:mm): Set the time when daylight saving time begins.

Set To (hh:mm): This is what the time will change to when daylight saving begins. For most regions, this will be one hour ahead of the “Start Time”.

End Date: Set the end date of daylight saving time.

End Time (hh:mm): Set the time when daylight saving time ends.

### 5.9.3 User



Figure 5.25 (System Menu – User)

User List: Click on the drop-down to select a user from the list. The default choices are admin, user2, and user3. Select “Add” to add a new user.

User name: The on-screen keyboard will pop up to allow you input the user name.

Password: The on-screen keyboard will pop up to allow you input the password.

Level: Set user’s level to one of the following: Operator, Manager, or Administrator. The access features of each level can be set in the Security section.

Status: Set user’s status to Enable or Disable.

Action: Click the “Delete” button to remove the selected user (admin cannot be deleted).

Note: Whenever a user is added or deleted, a record will be created in the event log.

When you are finished making changes, click the “Apply” button to confirm.

## 5.9.4 Security



Figure 5.26 (System Menu – Security)

**Login Protect:** Check the box to require user name and password when you enter configuration menu.

**Auto Logoff:** Check the box to force the system to automatically log off if left unused for 2 minutes. This will also force the remote web viewer to automatically log off after 10 minutes.

**Select user operation rights:** Select user operation rights for Camera, Record & Play, Alarm & Event, Schedule, Network, Disk, Display, System, Playback, Covert, Copy, PTZ

Operator: All users have access to this option.

Manager: Accessible by either manager or administrator level.

Administrator: Only accessible by administrator level.



### 5.9.5 I/O Control

Figure 5.27 is a screen shot of the I/O Control Setting Menu. This menu is to define the settings for controlling the DVR through RS232 or RS485.

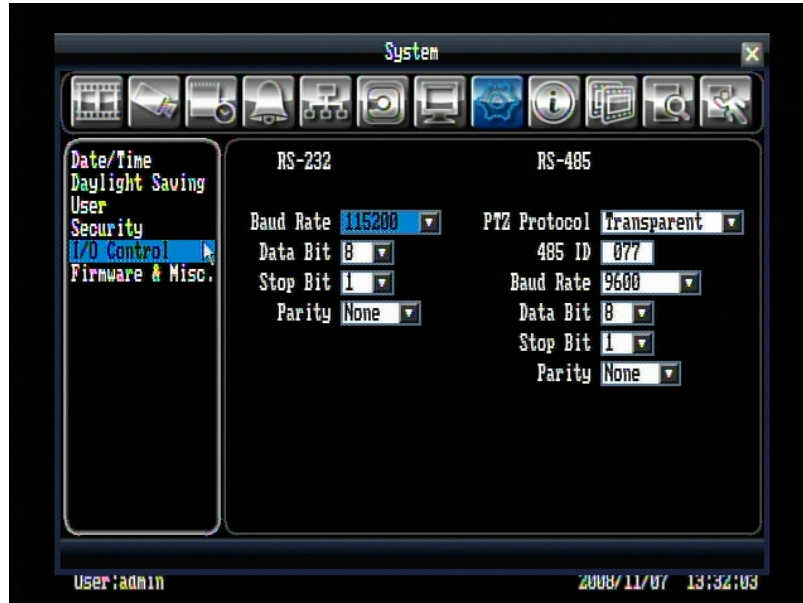

Figure 5.27 (System Menu – I/O Control)

#### RS232

**Baud Rate:** The speed used to transmit instruction or information through the RS232 port on the DVR. There are eight different speeds: 1200, 2400, 4800, 9600, 19200, 38400, 57600 and 115200 BPS.

**Data Bit:** The data bit used for transferring. There are two options: 8 or 7.

**Stop Bit:** This field is to set the stop bit for the RS232 connection. There are two options: 1 or 2.

**Parity:** This selects the level at which you will be connected. There are three options: None, Odd, or Even.

#### RS485

**PTZ Protocol:** Select PTZ protocol from Transparent, Pelco D, Pelco P, Everfocus, or Samsung.

**485 ID:** If more than one DVR is used through the RS485 connection, this can be used to assign different ID numbers. It is selectable from 0 to 127.

**Baud Rate:** The speed used to transmit instruction or information through the RS485 port on the DVR. There are eight different speeds, 1200, 2400, 4800, 9600, 19200, 38400, 57600 and 115200 BPS.

**Data Bit:** The data bit used for transferring. There are two options: 8 or 7.

**Stop Bit:** This field is to set the stop bit for the RS485 connection. There are two options: 1 or 2.

**Parity:** This selects the level at which you will be connected. There are three options: None, Odd, or Even.

## 5.9.6 Firmware & Misc.



Figure 5.28 (System Menu – Firmware & Misc.)

### Firmware

Current Firmware Version: Displays the current version.

Firmware Upgrade: Press “Upgrade” button to upgrade the firmware.

NOTE: To perform a Firmware Upgrade, you will need to connect a USB flash device with the latest version of the firmware

### Configurations

Load Factory Default: Click this “Load” button to restore all menu settings to the default values.

Load From USB: Click this “Load” button to upload saved DVR configuration settings from USB.

Save To USB: Click the “Save” button to save the current DVR configuration settings to USB device.

Language: System can be set in different languages. The available languages depend on the country or area, subject to change. Please consult your sales representative for the most updated information.

Remote Controller ID: Set remote control ID. This can be set from 1 to 4.

## 5.10 Information Setting

Figure 5.29 is a screen shot of the INFORMATION SETTING MENU. This menu will walk you through the System and log setup.



Figure 5.29 (Information Menu – System)

### 5.10.1 System

#### System

Version: Displays firmware version number.

Model: Displays DVR model number.

NTSC/PAL: Displays current video format.

#### Status

Disk: Displays disk temperature.

Fans: Displays fan status.

#### Network

IP: Displays the DVR's current IP Address.

MAC: Unique address of the DVR's internal network card. This option cannot be changed.

## 5.10.2 Log

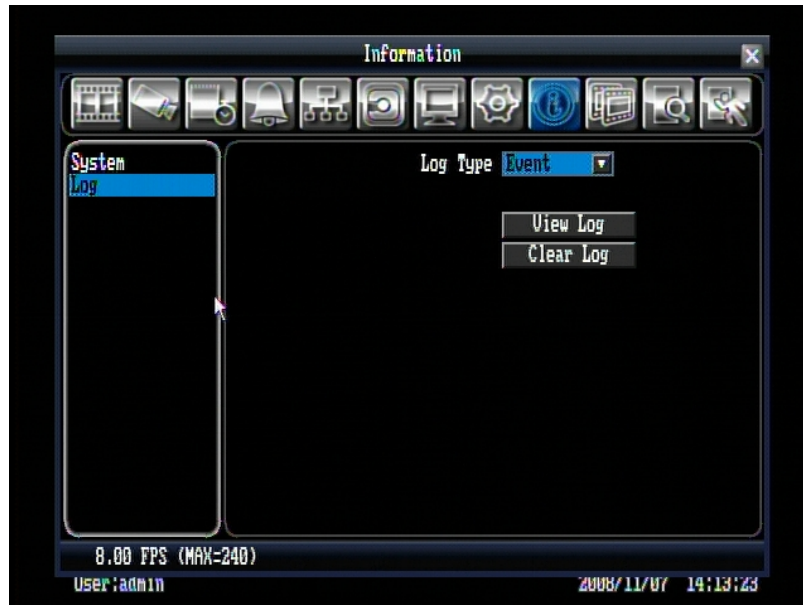

Figure 5.30 (Information Menu – Log)

Log Type:

Event: to see log sorted by event.

User: to see log sorted by user.

Operation: to see log sorted by operation.

View Log: Press "View Log" button to view the log. See Figure 5.31 for more detail.

Clear Log: Press "Clear Log" button to clear the log.



Figure 5.31 (Log List)

: Go to the first page of log.

: Go to the previous page of log.

: Go to the next page of log.

: Go to the last page of log.

Date/Time: Check the box to show log date/time.

ID: Check the box to show detailed log information.

## 6 Networking Overview

This chapter will give you a basic instruction on how to set up the DVR for network connection. It is highly recommended that you have a working knowledge of what a network is and how it works. This will be helpful in completing the networking process.

### 6.1 Introduction to TCP/IP

TCP/IP is the group of protocols used by the Internet and most Local Area Networks (LANs) throughout the world. In TCP/IP, every computer or other communications device that is connected to the network has a unique IP address. By doing this you are giving your device a unique address similar to the address of your house. An IP address is composed of four octets (numbers in the range of 0 to 255) separated by decimal points. The IP address is used to uniquely identify a host or computer on the LAN. For example, one computer on a network could have an IP address of 192.168.1.127.

You should never give two or more devices the same exact IP address, but the first three octets of an IP address should be the same for all computers in the local area network. For example, if a total of 253 computers exist in a single LAN, the IP addresses could be assigned starting with 192.168.1.x, where x represents a number in the range of 2 to 254.

### 6.2 Subnet Masks

Each host in a LAN has a subnet mask. The subnet mask is a set of octets that is used to determine which LAN or class it belongs to. The number 255 is usually used to represent the network address portion of the IP address and a zero is placed at the end to identify the host portion of the address. Basically the subnet mask can be compared to the city you live in for your home address, but in this case you are stating the network you belong to.

### 6.3 Gateway Address

Each host in a LAN has a gateway. A gateway address is composed of four octets separated by decimal points. The gateway address is used to uniquely identify the main host or computer on the LAN that assigns the IP addresses to your network (usually a router). This is comparable to the zip code of your address.

## 6.4 Virtual Ports

A port number represents a "channel" or entryway for network communications. Port numbers allow different applications on the same computer to utilize network resources without interfering with each other. Port numbers most commonly appear in network programming, particularly socket programming. Sometimes, though, port numbers are made visible to the casual user. For example, some websites on the Internet use a URL like the following:

`http://www.fakeaddress.com:8100/`

In this example, the number 8100 refers to the port number used by the browser to connect to the web server. The standard port number used by web sites is 80, so this number does not need to be included with the URL (although it can be). In IP networking, port numbers can theoretically range from 0 to 65535. Most popular network applications, though, use port numbers at the lower end of the range (such as 80 for HTTP). Ports are similar to doors and windows of your house, with port 80 acting as the front door. If these are not open you could not enter the house. This is the same case with ports on a network. If the ports for a specific IP address are not open then you could not gain access to that IP address.

Note: The term port also refers to several other aspects of network technology. A port can refer to Ethernet connection points, such as those on a hub, switch, or router. The term port is also used to refer to a physical connection point for peripheral devices such as serial, parallel, and USB ports.

## 6.5 Pre-Installation

Before beginning the installation, please answer the following questions:

Do you have Hi-speed Internet? \_\_\_\_\_

There are many types of high speed Internet available. The most common ones are T1, Cable, and DSL (in order of speed). The DVR is not compatible with a dial-up connection.

- Note: EverFocus suggests having a minimum upload speed of 256KBps. This can be addressed by your Internet Service Provider.

What type of modem/router do you have? \_\_\_\_\_  
Modem/router model name/ #

The modem/router was either installed by your Internet service provider or purchased by you to establish a connection to the Internet. A router assigns different internal IP addresses to local computers; this allows multiple computers to access the Internet through the same external IP address.

Do you have a static IP address? \_\_\_\_\_

A Static IP address means you use the same IP address every time you connect to the Internet. With a static IP address, other Internet users always know the address of your location and can easily connect with it. This makes it much simpler to host a website, email server, or other type of server connection. Everfocus suggests using a static IP address. If this is not available, you will need to use a dynamic IP address. This is explained below.

Do you have a dynamic IP address? \_\_\_\_\_

A Dynamic IP address means your IP address changes each time you connect to the Internet. We recommend asking your Internet service provider for a Static IP address. If this is not a possibility, you may use the DDNS feature of the DVR. DDNS stands for Dynamic Domain Name Server, a service that provides a central database where IP information can be stored and retrieved. It allows those using a dynamic IP address to be registered centrally so users can connect to it by name. See Chapter 8 for details on using EverFocus DDNS.

What type of DVR are you installing? \_\_\_\_\_

Everfocus EDR series: EDR 410, 810, 920, 1620, 1640, or 1680

Everfocus EDVR series: EDVR 4D1, 9D1, 16D1, 16D3

Everfocus ECOR series: ECOR 4, 8

## 6.6 What is your Network Setup?

Everfocus DVR's can operate using one of three types of networking connections.

1. **Simple One to One Connection:** A simple one to one connection is the simplest type of network connection. It uses a cross-over cable to make a direct connection from one computer to another (or in this case a computer to a DVR).
2. **Direct High Speed Modem Connection:** A direct modem connection uses a standard network cable to connect the modem directly to a computer (or in this case a modem to the DVR). This type of connection only covers single-port modems. For a combination modem/router, use the setup described below.
3. **Router or LAN Connection –** A local area network connection requires either a router or a pre-existing LAN connection. This is the most common type of connection. A router allows multiple computers and DVR's to access each other as well as the Internet. It assigns different internal IP addresses to the computers.



## 6.7 Simple One to One Connection

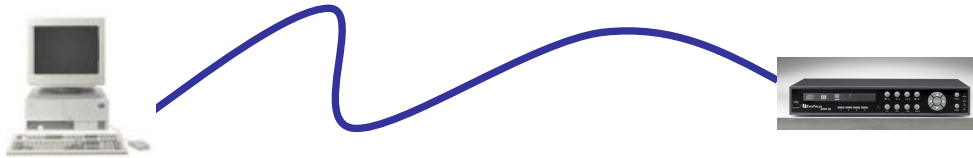

**Cat 5  
Cross-over-cable**

Crossover Ethernet Cable Pin outs:

The Figure below shows the pin configurations for a cross-over cable.

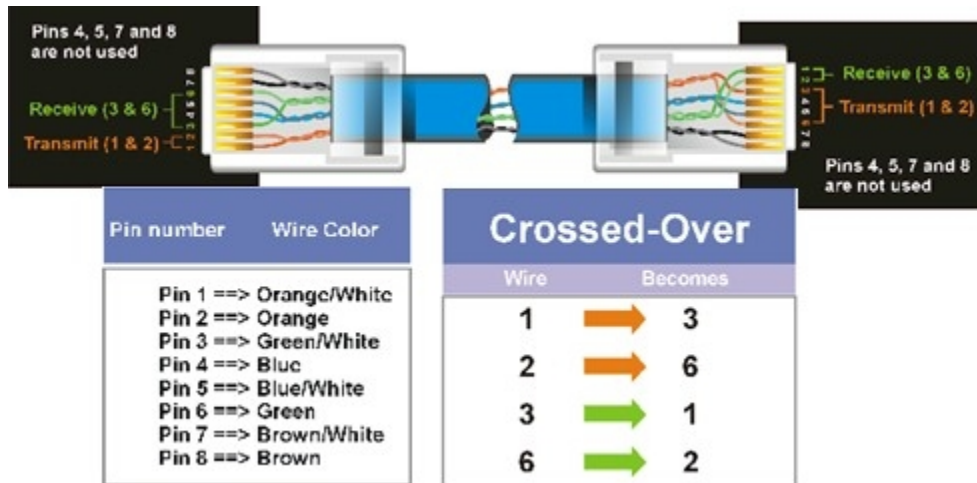

Connection Procedure:

- The First step is to purchase or make a cross-over cable. We recommend purchasing one if you have never made a cross-over cable. Please remember you can not use a straight through network cable for this application
- Once you have a cross-over cable plug one end into the LAN port on the back of the DVR and the other into the network card on the back of the computer.
- Log into the EverFocus DVR menu and go to the Network Setting Menu.
- You must use the Static IP option for this type of connection.

- Assign an IP of 192.168.001.003, a Subnet Mask of 255.255.255.000, and a Gateway of 192.168.001.001. You can ignore DNS Server.
- The next step is to set the computer's network settings to match those of the DVR. You will need Administrator privileges on your Windows machine to do this.
- To assign a fixed IP address in Windows 2000/XP.

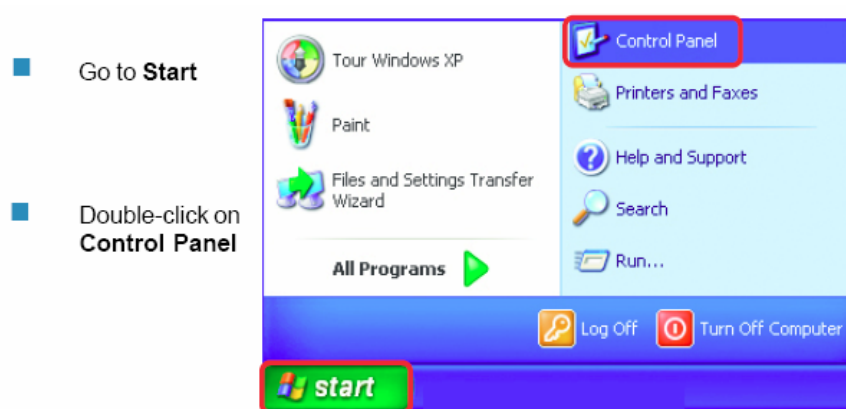

- Double-click on **Network Connections**

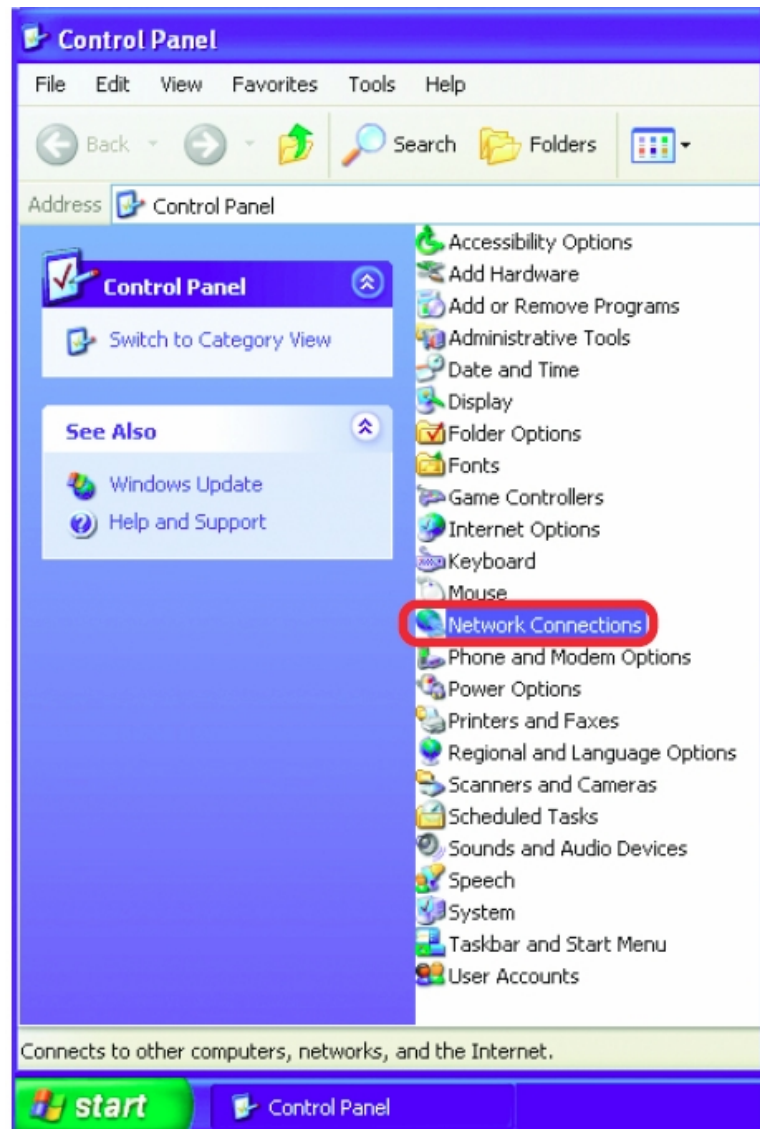

- Right-click on **Local Area Connections**

- Double-click on **Properties**

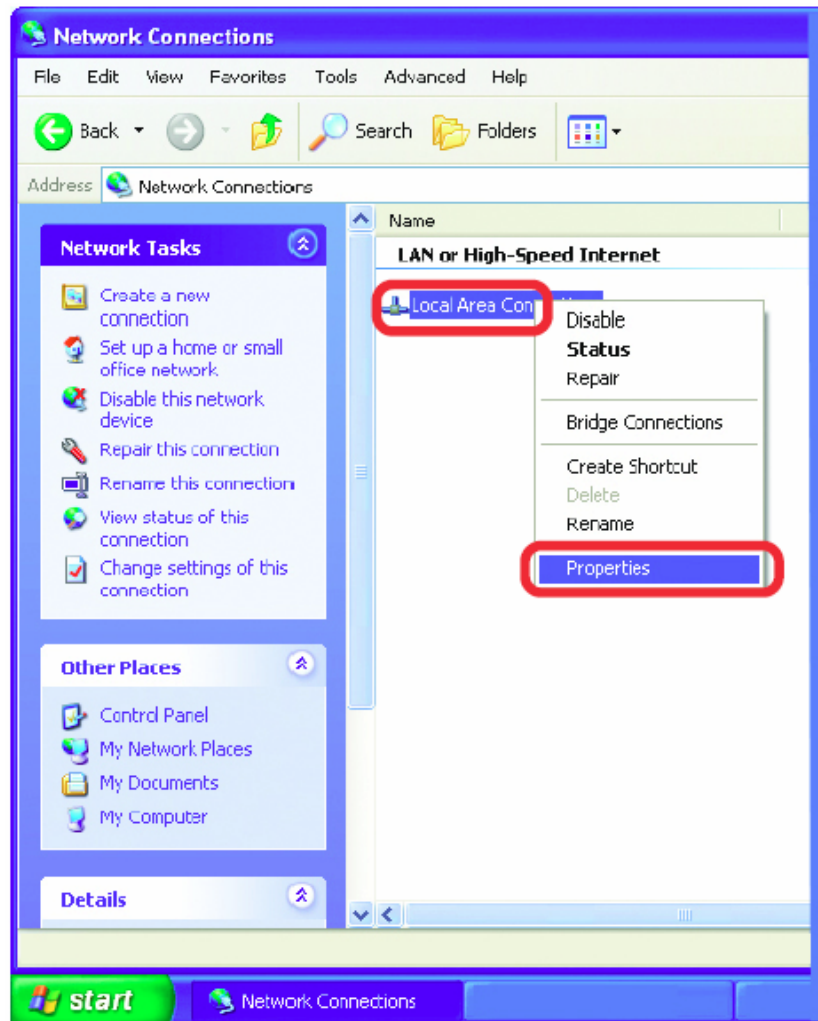

- Click on **Internet Protocol (TCP/IP)**
- Click **Properties**

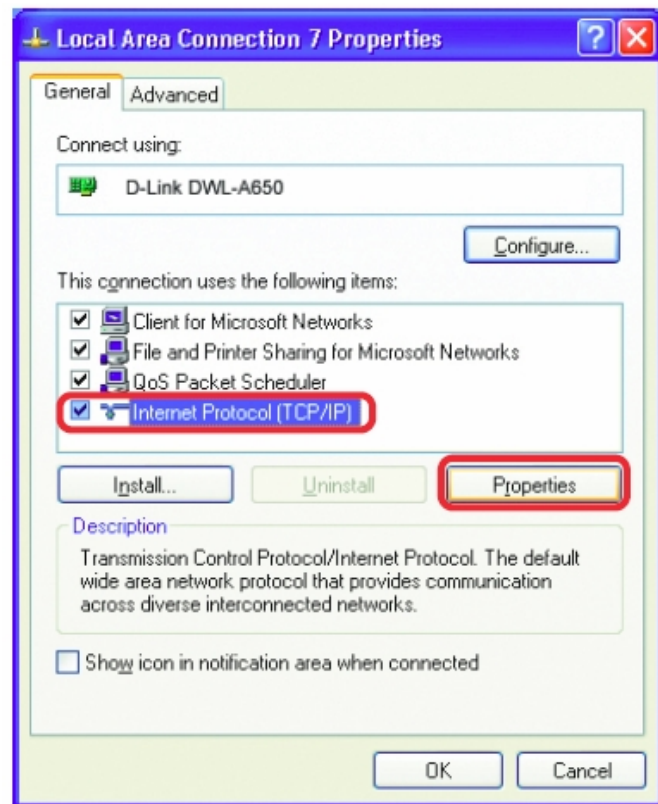

- Click on the option that says "Use the following IP address"
- Assign an IP address of 192.168.1.2, a Subnet Mask of 255.255.255.0, and a Default Gateway of 192.168.1.1, then click OK.
- Restart both the computer and the DVR.
- To access the DVR from the computer, simply open Internet Explorer and in the address bar type:

<http://192.168.1.3>

## 6.8 Direct High Speed Modem Connection

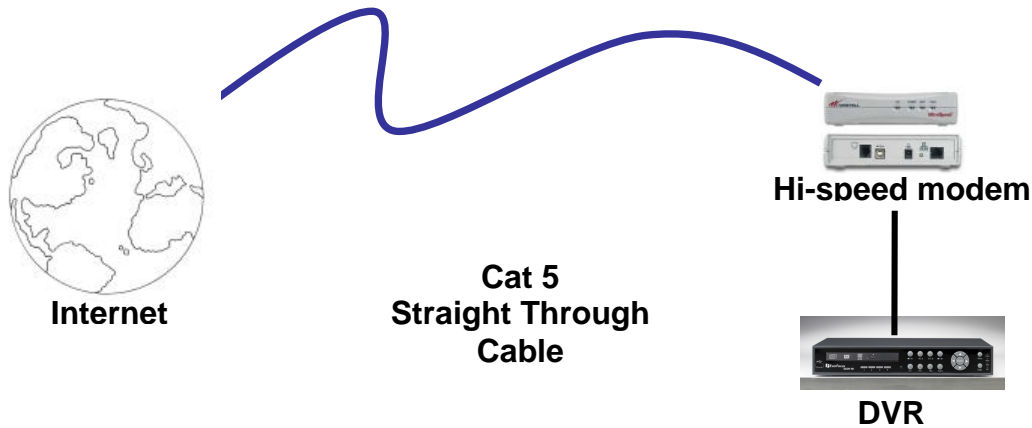

Straight Through Ethernet Cable Pin outs:

The Figure below shows the pin configurations for a straight cable.

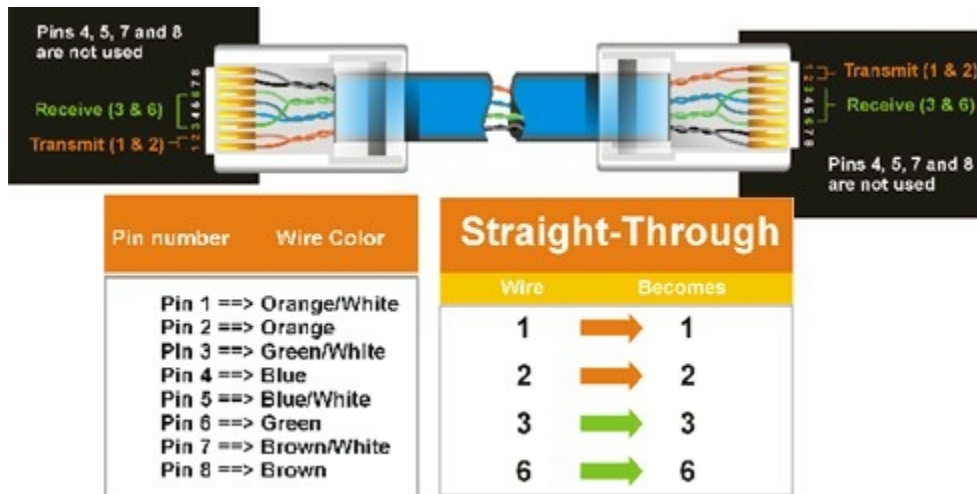

Connection Procedure:

- The first step is to purchase or make a straight through cable. We recommend purchasing one if you have never made a straight through cable. Please remember you can not use a cross-over network cable for this application
- Once you have a straight through cable plug one end into the LAN port on the back of the recorder and the other into the high speed modem.

- Log into the EverFocus DVR menu and go to the Network Setting Menu.
- Input the Static IP address, the Subnet Mask, and the Gateway that you obtained from the internet service provider.
  - Note: If you have a dynamic IP address, you can set the DVR to DHCP to automatically detect the network settings settings. Therefore, it can use a dynamic IP address.
- Exit from the DVR's Menu to save the settings.
- To access the DVR from a computer, open Internet Explorer and in the address bar type:  
http:// (IP address given by your internet service provider)
  - Note: When using this type of connection, only one device can be connected to the modem at a time. You will need to use a computer at a different location to test the connection.

## 6.9 Router or LAN Connection

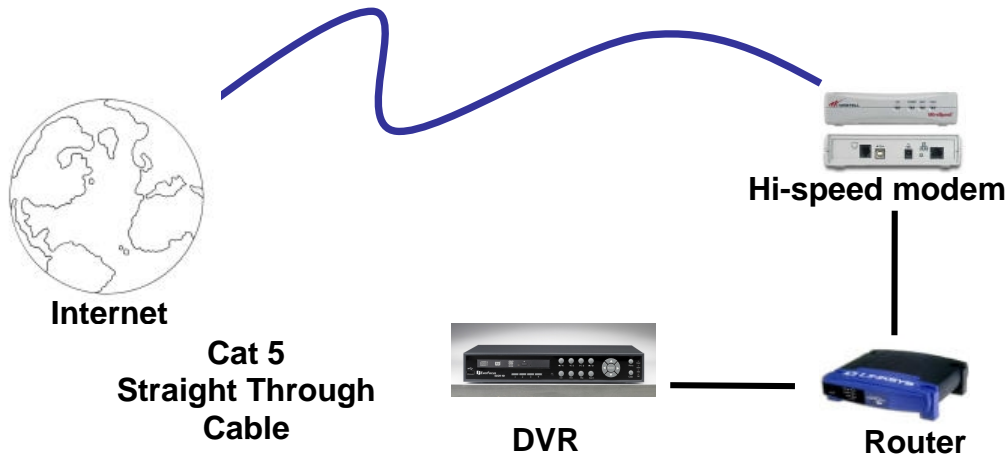

Straight Through Ethernet Cable Pin outs:

The Figure below shows the pin configurations for a straight cable.

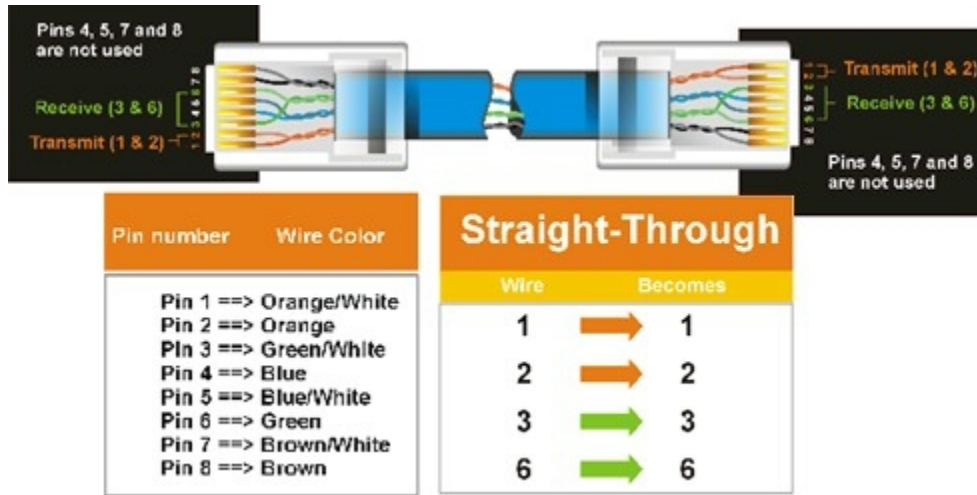

Connection Procedure:

- The First step is to purchase or make a straight through cable. We recommend purchasing one if you have never made a straight through cable. Please remember you can not use a cross-over network cable for this application
- Once you have a straight through cable plug one end into the LAN port on the back of the recorder and the other into the router.



- Log into the EverFocus DVR menu and go to the Network Setting Menu.
- To let the router automatically assign an address:
  - Set the Network Type to DHCP. Make sure to write down the IP address and the Gateway.
  - Exit from the Menu to save settings.

To manually assign an address:

- Go to a computer connected on the same network as the DVR.
- Click on the Start button and choose Run.
  - If using Windows Vista, choose Search instead.
- Type "command" and click on OK.
  - In Vista, you will need to double-click on the "Command Prompt" file to open it.
- In the DOS prompt, type "ipconfig" and press Enter.
- The network information will be displayed on a screen similar to the one below.
  - In Windows Vista, look for the information that says "IP v4".

```
CA Command Prompt
Microsoft Windows XP [Version 5.1.2600]
(C) Copyright 1985-2001 Microsoft Corp.

C:\Documents and Settings\Steven>ipconfig

Windows IP Configuration

Ethernet adapter Local Area Connection:

    Connection-specific DNS Suffix . . . :
    IP Address . . . . . : 192.168.0.80
    Subnet Mask . . . . . : 255.255.255.0
    Default Gateway . . . . . : 192.168.0.1

C:\Documents and Settings\Steven>
```

- Take the values for Subnet Mask and Default Gateway and input them into the DVR; these values should be exactly the same in both devices. However, you should change the last number of the IP address. For example, if the IP address of the computer is 192.168.2.101, the DVR's IP address should be 192.168.002.050.

- To access the DVR from a computer simply open Internet Explorer and in the address bar type:  
http:// (IP address of the DVR)
  - Note: The DVR's IP address will only work at the location of the DVR. To connect from a different location over the Internet, see below.

To set DVR for Internet Connection through router

- The next step is to open ports within your router. Log into the router using a PC and open the following ports.
  - ECOR Ports to open: 80, 1600
  - If your Internet service provider blocks port 80, you can change it to a different port in the DVR's Network Menu Setup.
  - If you are using a Linksys or D-Link router, see Chapter 9 for basic support on setting up ports. For any other router, you will need to contact the manufacturer for support.
- To access the DVR from a computer simply open Internet Explorer and in the address bar type:  
http:// (the IP address given by your internet service provider)
  - Note: If you changed to a different port other than 80, you will need to include this at the end of the IP address  
Example: <http://70.20.70.20:8100>
- If you have a Dynamic IP address and have opened the ports, go to the next chapter to setup DDNS.

## 7 Remote Operation from Browser

### 7.1 Connecting to ECOR

To access the DVR from a computer, open an Internet Explorer window and in the address bar type:

Local connection: http:// (IP address from the DVR's Network Menu)

Internet connection: http:// (IP address given by your Internet Service Provider)

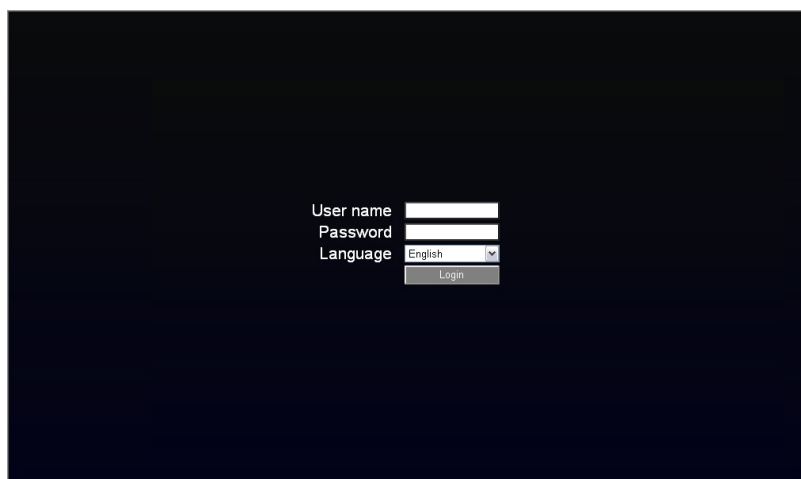

- The login page will appear on the screen similar to the one shown above.
- Enter a user name and password to access the recorder. These can be changed in the System section of the Main Menu.
- The Default user name and password are admin and 11111111.
- Click on the Login button and you will log in to the recorder's Network Viewer.

## 7.2 IE Browser Setting & Active X Control Installation

### 7.2.1 Installing ActiveX controls

When you first connect to the DVR's IP address, you should see a screen like the one below. If you do not see a yellow bar like the one the arrow is pointing at, your security settings may be too high. If so, go to the section labeled "Enabling ActiveX Controls."

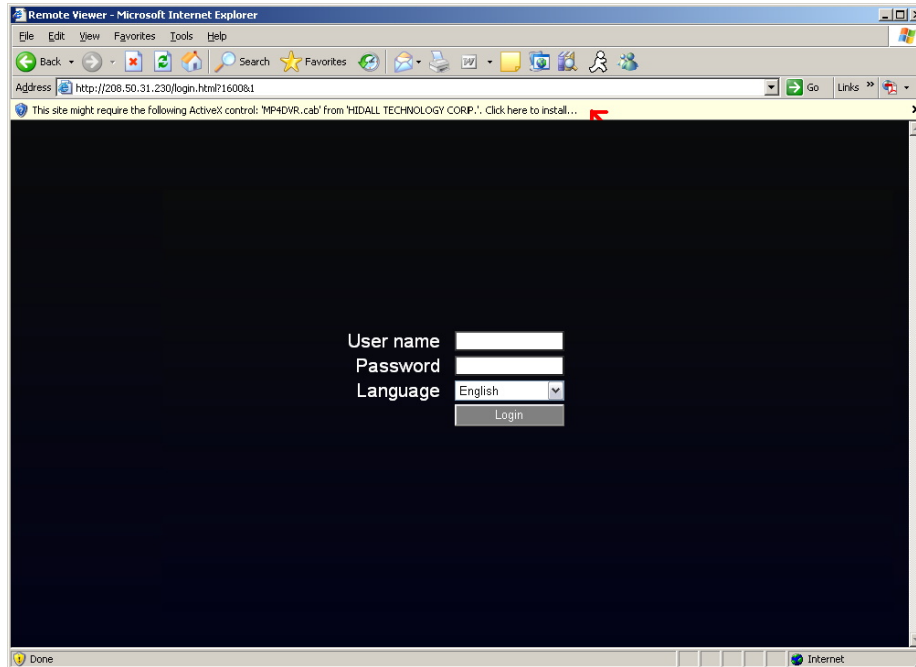

Right click on the yellow bar and select "Install ActiveX Control..."

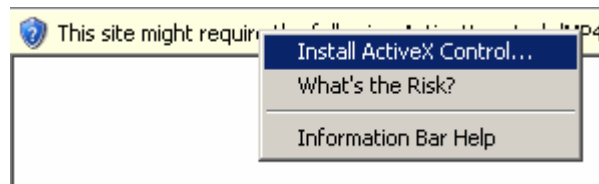



Install the eDVR.cab file when prompted to do so.

Once the file finishes installing, you will return to the same login page as before.

Type in the username and password and click Login to view the cameras.

Default username: admin

Default password: 11111111

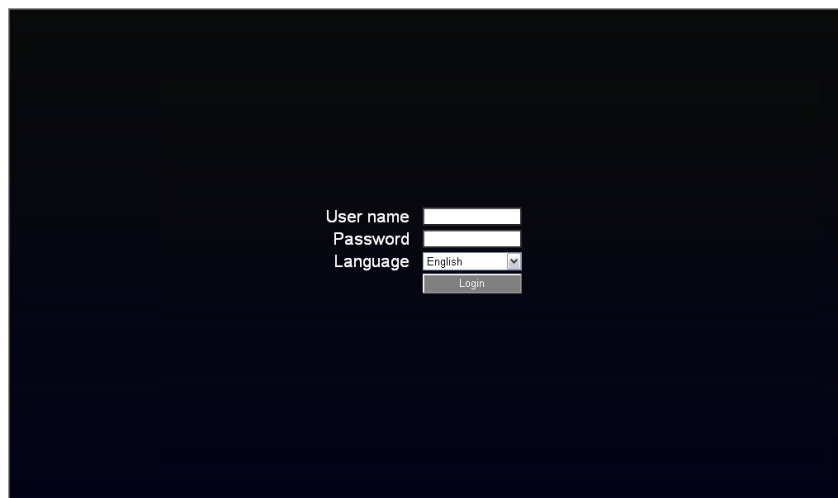

## 7.2.2 Enabling ActiveX Controls

Note: This section is only necessary if you DO NOT see the yellow ActiveX bar at the top of your browser screen when you first connect to the DVR.

At the top of the Internet Explorer Window, click on Tools, then select Internet Options.



Click the Security tab at the top of the window, then choose Custom Level near the bottom.

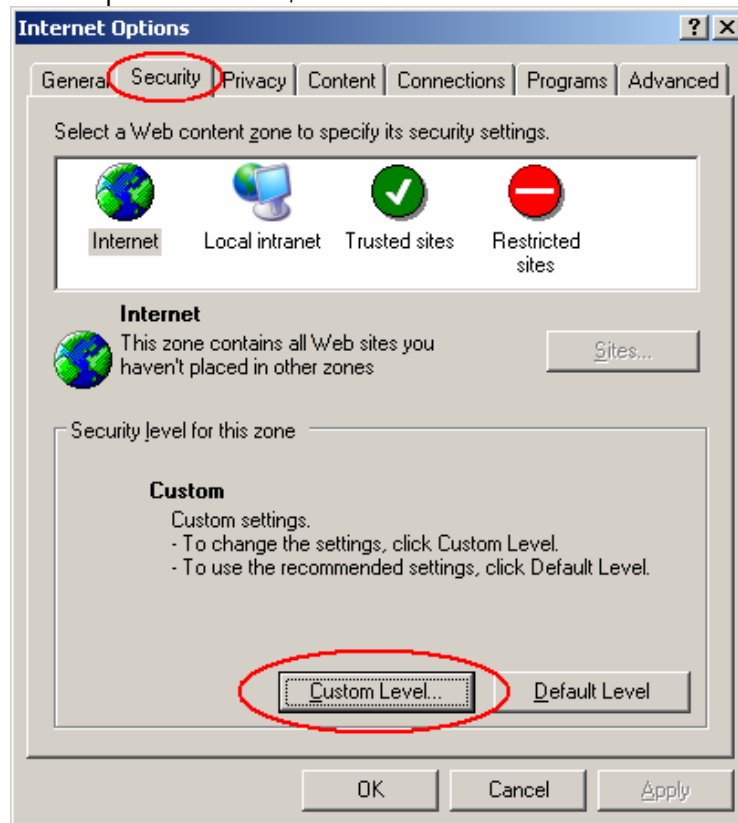

In the Security Settings window, scroll to “ActiveX controls and plug-ins”

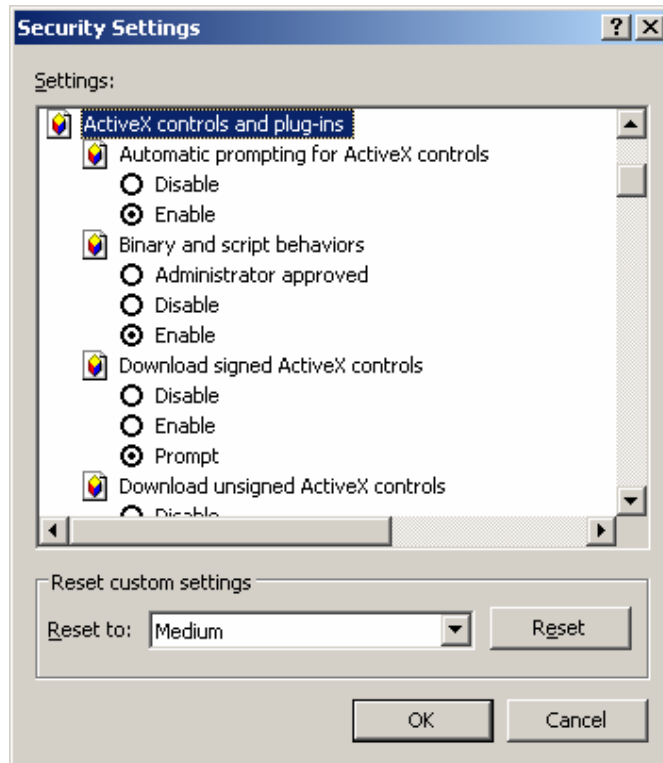

Set the controls as follows:

“Enable”:

- ✓ Allow previously unused ActiveX controls to run without prompt (Internet Explorer 7 only)
- ✓ Allow scriptlets (IE7 only)
- ✓ Automatic prompting for ActiveX controls
- ✓ Binary and script behaviors
- ✓ Display video and animation on a webpage that does not use external media player (IE7 only)
- ✓ Run ActiveX controls and plug-ins
- ✓ Script ActiveX controls marked safe for scripting

“Prompt”:

- ✓ Download signed ActiveX controls
- ✓ Download unsigned ActiveX controls

“Disable”:

- ✓ Initialize and script ActiveX controls not marked as safe

Click OK and then choose Yes to change the security settings.

Close the window so you are back at the login screen.  
Click the Refresh button to reload the page.

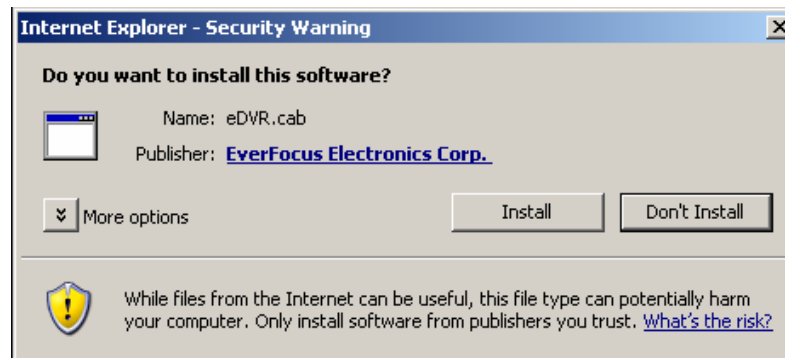

Install the eDVR.cab file when prompted to do so.

Once the file finishes installing, you will return to the same login page as before.  
Type in the user name and password and click Login to view the cameras.  
Default user name: admin  
Default password: 11111111.

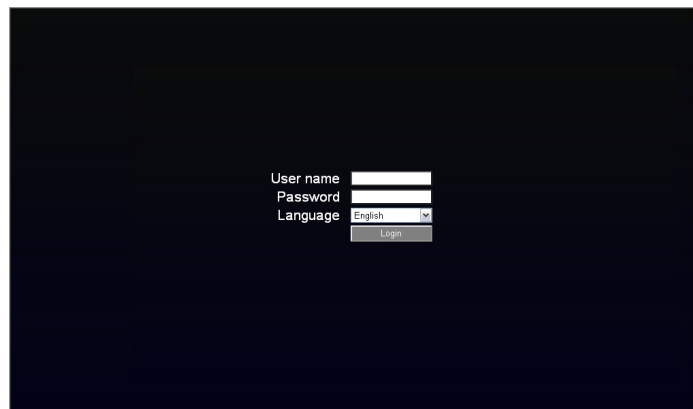



## 7.3 Remote Live View



1. In the main page, you will see live images in a 4-screen display (or 9 screens, depending on the model).
2. The status of all cameras as represented by different colors in the top left corner. Green means normal; yellow means a motion/Vloss event is happening; red means an alarm event is happening; and grey means the camera is disabled. Click on a camera number to switch that camera to full screen. Click on "4UP" to return to 4-screen display. Click on "OSD" to turn the On Screen Display information on or off.
3. There are 13 setup icons at the top of screen. The first twelve have the same functions as the icons in the DVR's Main Menu. The last icon (PTZ control) is described in the next section.

## 7.4 Remote PTZ Control



1. Select the PTZ camera from drop-down menu.
2. Use Direction Arrows (up, down, left, right) to move the camera to the desired direction and angle.
3. In the Iris option, you can decrease by clicking C the amount of light or increase it by clicking O.
4. In Focus option, click F to decrease the focus or click N to increase the focus.
5. Under Zoom, Click "IN" to zoom closer or "OUT" to zoom farther away.
6. In the keypad section, click on the numbers to input a desired pre-set position.
  - Click Set to confirm a position
  - Click Clear to delete a position
  - Click GO to jump to a position.
7. AUTO-PAN allows you to choose the movement speed used for pre-set positions and tours. Select from Lower, Low, Middle, High, or Higher.
8. TOUR allows you to select an automatic tour. You can set up to 16 tours.
9. SPEED allows you to select the movement speed when manually controlling the camera. The 4 options available are 1X, 5X, 10X, and Continuous.

## 7.5 Remote Playback

To playback the video, press "Search" button. Select from "Time Search", "Event Search", or "Motion Search". For more details about Search setting, please refer to "4.8 Search Setting".

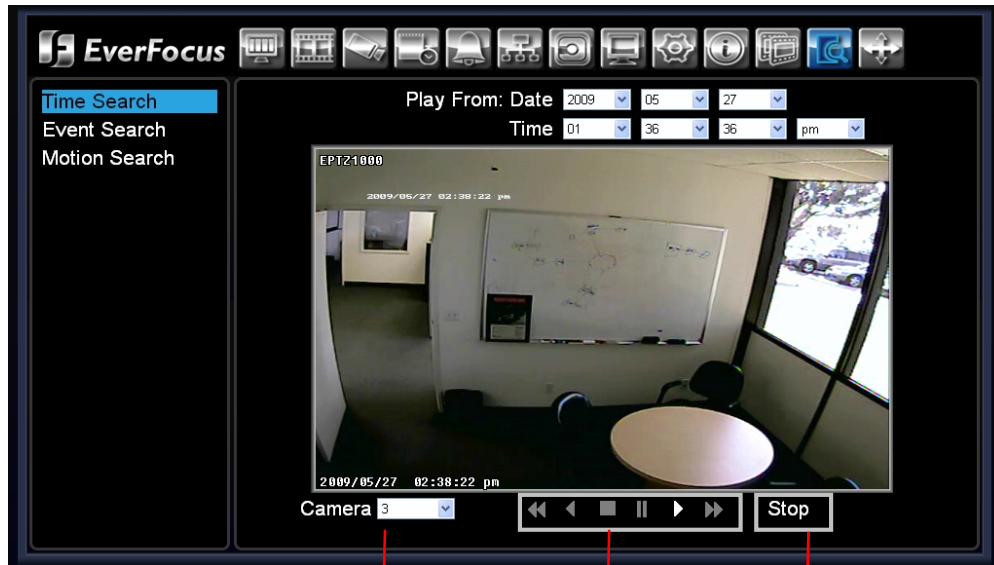





Select Camera

Playback Control

Play Status

Playback Control Keys:

1.  Fast Reverse.
2.  Play Reverse.
3.  Stop playback.
4.  Pause playback.
4.  Play Forward.
5.  Fast Forward.

## 8 EverFocus DDNS Setup

### Setup Steps:

Step 1. Set up the Network Menu according to the instructions detailed in the Networking chapter. (Make sure that DNS Server 1 is set correctly or DDNS will not work)

Step 2. Go to the website <http://everfocusddns.com> and check for an available name.

Note: This step is optional, as it is only used to check the availability of host name. If the name is available, proceed to step 3 for DDNS setup.

Step 3. In DVR's Network Menu, go to DDNS. Choose "EverfocusDDNS" for the Server and put in your chosen name for DVR Name.

Step 4. Press "Submit/Update" button to confirm.

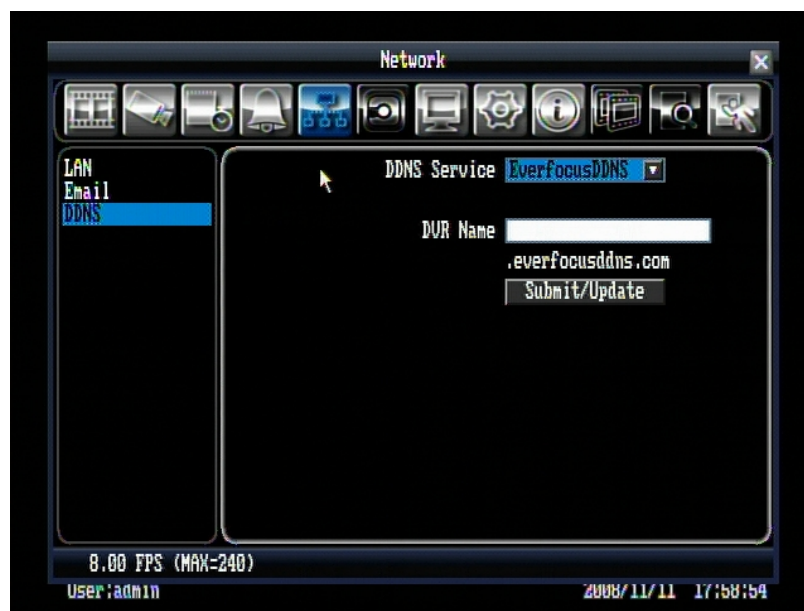

Step 5. You should now be able to connect by typing the host name you created in browser.  
Example: <http://hostname.everfocusddns.com>

## 9 Linksys & D-Link Port Forwarding

### 9.1 Linksys Port Forwarding

This section will cover a few simple configurations for the Linksys router. This chapter is only to offer some help to the installer and end user. Please understand we DO NOT support this product and will not give tech support on it. If you need additional technical support on this router you must call Linksys.

To access the Web-based Utility, launch a web browser and type the Router's default IP address, 192.168.1.1, in the address bar. Then press Enter. A password request page will appear. (Non-Windows XP users will see a similar screen.) Leave the User Name field blank. The first time you access the router, use the default password admin. Click the OK button to continue.



The first screen that appears displays the Setup tab. This allows you to change the Router's general settings. Change these settings as described here and click the Save Settings button to apply your changes or Cancel Changes to cancel your changes.

Click on the "Applications & Gaming" tab.

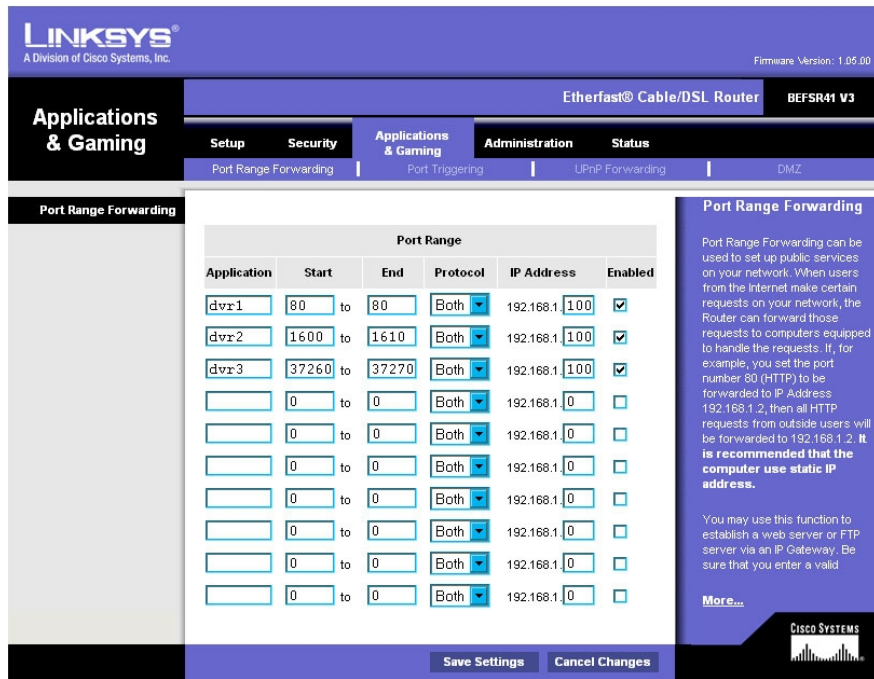

Applications and Gaming allows you to set up public services on your network, such as web servers, ftp servers, e-mail servers, or other specialized Internet applications. (Some Internet applications may not require any forwarding) To forward a port, enter the information on each line for the criteria required. Descriptions of each criterion are described here.

Application - In this field, enter the name you wish to give the application.

Start/End - Enter the starting number of the range under Start and the ending number under End.

Protocol - Enter the protocol used for this application, either TCP or UDP, or Both.

IP Address - For each application, enter the IP Address of the PC running the specific application.

Enable - Click the Enable checkbox to enable port forwarding for the relevant application.

When finished making changes, click the Save Settings button to apply your changes or Cancel Changes to cancel them.

Here is an example for how the port information might look:

HTTP	80 to 80	Both	192.168.1.50	Enable
CTRL	1600 to 1600	Both	192.168.1.50	Enable

- Note: If you changed port 80 in the DVR's Network Menu, open that port instead of 80.

## 9.2 D-Link Port Forwarding

This section will cover a few simple configurations for the D-Link router. This chapter is only to offer some help to the installer and end user. Please understand we DO NOT support this product and will not give tech support on it. If you need additional technical support on this router you must call D-Link.

Whenever you want to configure your network or the DI-624, you can access the Configuration Menu by opening a web-browser and typing in the IP Address of the DI-264.

The DI-264 default IP Address is 192.168.0.1.

- Type "admin" in the User Name field
- Leave the Password blank
- Click OK



The first screen that shows up is the Home Tab. This is the starting point for all the router's settings and functions.

Click Virtual Servers on the left to bring up the following screen.



Virtual Servers allows users who are connecting remotely to access services on the router's Local Network. The functions of each field are described below.

Virtual Server - Select Enabled or Disabled

Name - Enter the name referencing the virtual service

Private IP - The IP address of the device running the local services.

Protocol Type - The protocol used for the virtual service.

Private Port - The port number that the service uses on the LAN (Local Area Network).

Public Port - The port number that the services uses on the WAN (Wide Area Network).

Schedule - The time period the virtual server will be active.



When you have input all the information for a virtual server, click on Apply to add it to the list at the bottom or Cancel to clear all fields.

Here is an example of the information for each service:

<u>Name</u>	<u>Private IP</u>	<u>Protocol</u>	<u>Private Port</u>	<u>Public Port</u>	<u>Schedule</u>
HTTP	192.168.1.50	Both	80	80	Enable
CTRL	192.168.1.50	Both	1600	1600	Enable

- Note: If you changed port 80 in the DVR's Network Menu, open that port instead of 80.

## 10 Troubleshooting

If you have problems with the system, run through the following checklist to see if you can solve the problem.

- The DVR will not go into record mode.
  - Bring up the DVR's Menu and check under the Camera Menu. Verify that all connected cameras are checked as "Installed" and that Record Mode is set to "Continuous".
  - Check the Disk Menu and verify that the internal hard drive is being detected.
  
- The DVR displays no picture.
  - Make sure the monitor is connected to either the Video Out port or the VGA port. If the monitor has multiple inputs, make sure it is on the correct display setting.
  - Check that the monitor cables are good.
  - Verify the recorder is getting the correct amount of power.
  
- There is no display coming from one of the channels on the DVR.
  - In the DVR's Camera Menu, make sure that all cameras are checked as "Installed" and unchecked for "Covert".
  - If there is still no picture, connect a working camera to the port that has no picture. If you get an image, the problem is coming from the camera.
  
- I cannot connect to the recorder via the internet.
  - Check that the DVR's ports are forwarded correctly in the router.
  - Verify that your Internet Service Provider does not block any ports.
  - Make sure you are using the correct IP address given by the ISP, or, if you have a Dynamic IP, check if the number has changed.

## Appendix A: Timing Of Alarm Modes

### Transparent Mode

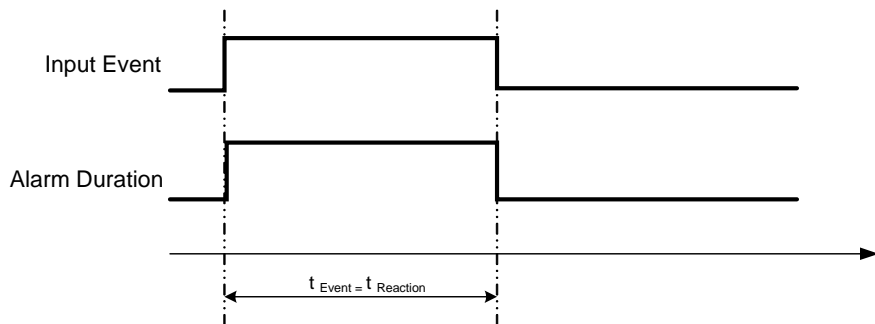

$t_{Event}$ : Duration of alarm input source (motion, contact, system events...)

$t_{reaction}$ : Resulting duration for this alarm mode, related to event record, alarm outputs, OSD message, buzzer

### Timeout + Transparent Mode

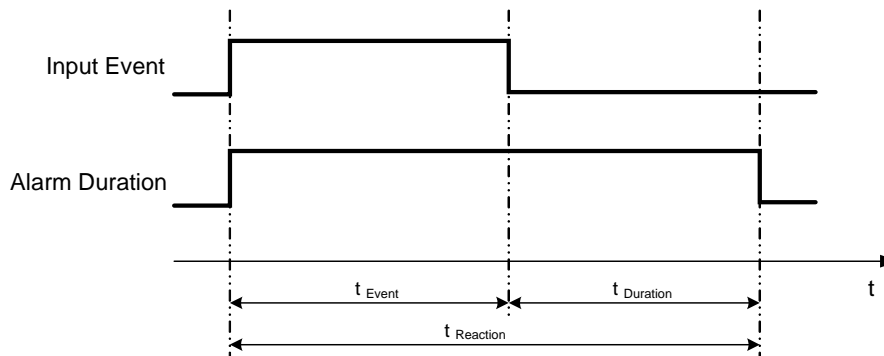

$t_{Event}$ : Duration of alarm input source (motion, contact, system events...)

$t_{Duration}$ : Alarm duration for timeout, defined in the event setup menus

$t_{reaction}$ : Resulting duration for this alarm mode, related to event record, alarm outputs, OSD message, buzzer

## Timeout Mode

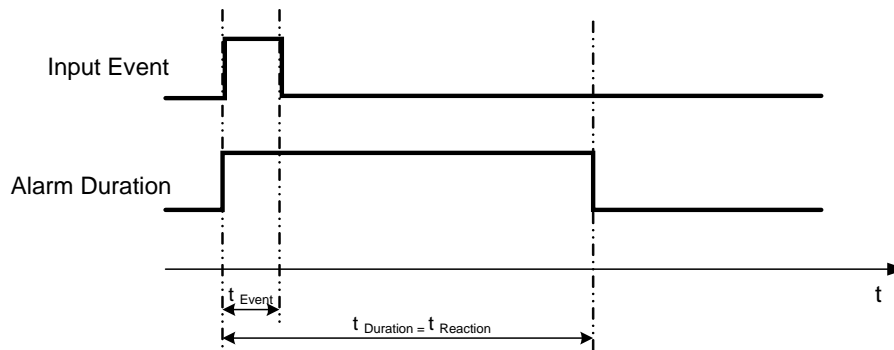

$t_{\text{Event}}$ : Duration of alarm input source (motion, contact, system events...)

$t_{\text{Duration}}$ : Alarm duration for timeout, defined in the event setup menus

$t_{\text{reaction}}$ : Resulting duration for this alarm mode, related to event record, alarm outputs, OSD message, buzzer

## Permanent Mode

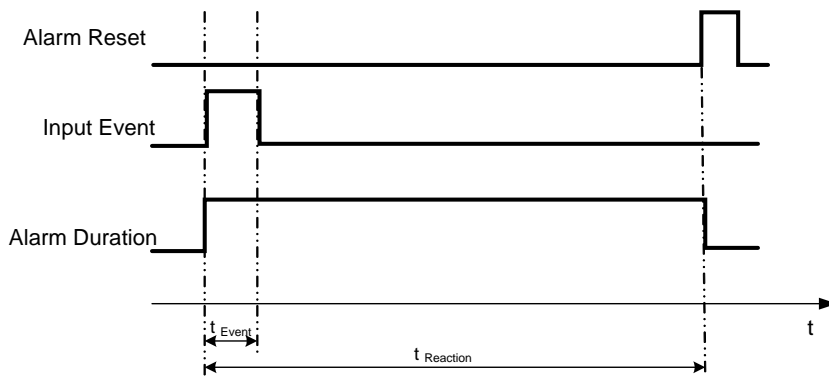

$t_{\text{Event}}$ : Duration of alarm input source (motion, contact, system events...)

$t_{\text{Duration}}$ : Alarm duration for timeout, defined in the event setup menus

$t_{\text{reaction}}$ : Resulting duration for this alarm mode, related to event record, alarm outputs, OSD message, buzzer

Timeout Mode: Retrigger of Alarms

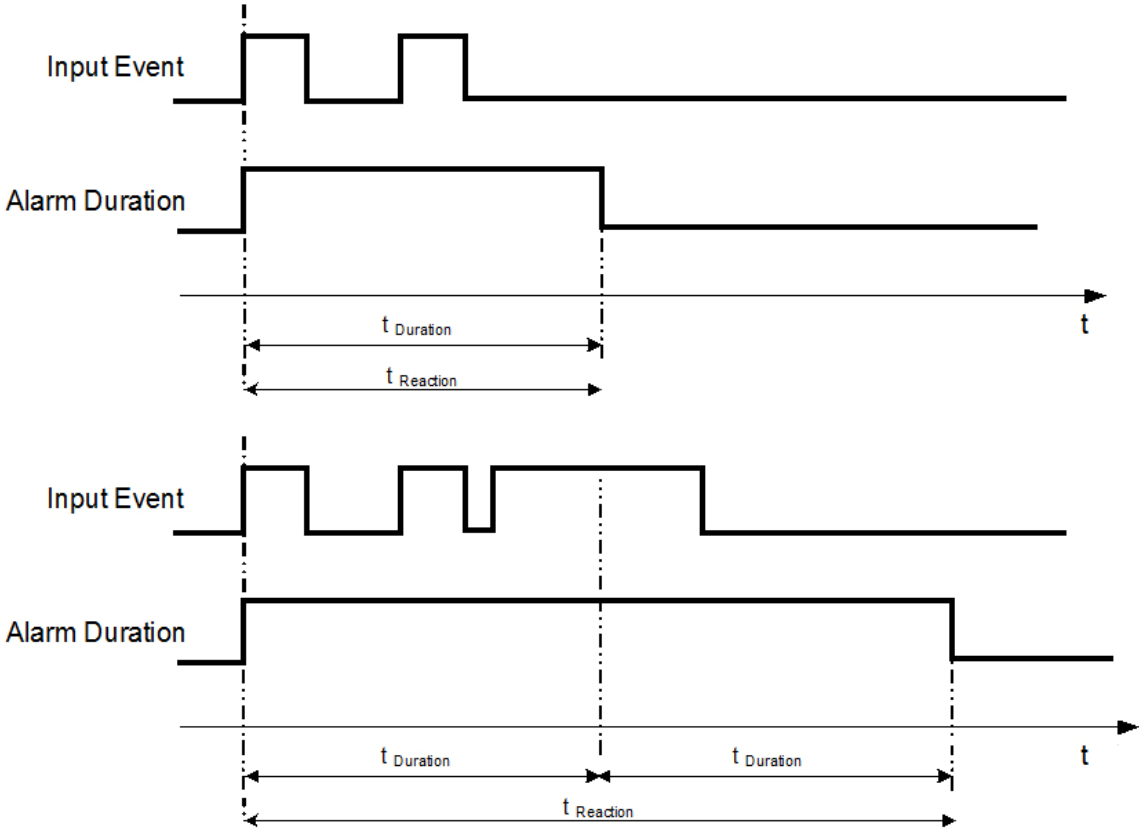

- $t_{\text{Event}}$ : Duration of alarm input source (motion, contact, system events...)
- $t_{\text{Duration}}$ : Alarm duration for timeout, defined in the event setup menus
- $t_{\text{reaction}}$ : Resulting duration for this alarm mode, related to event record, alarm outputs, OSD message, buzzer

## Timeout+Transparent Mode: Retrigger of Alarms

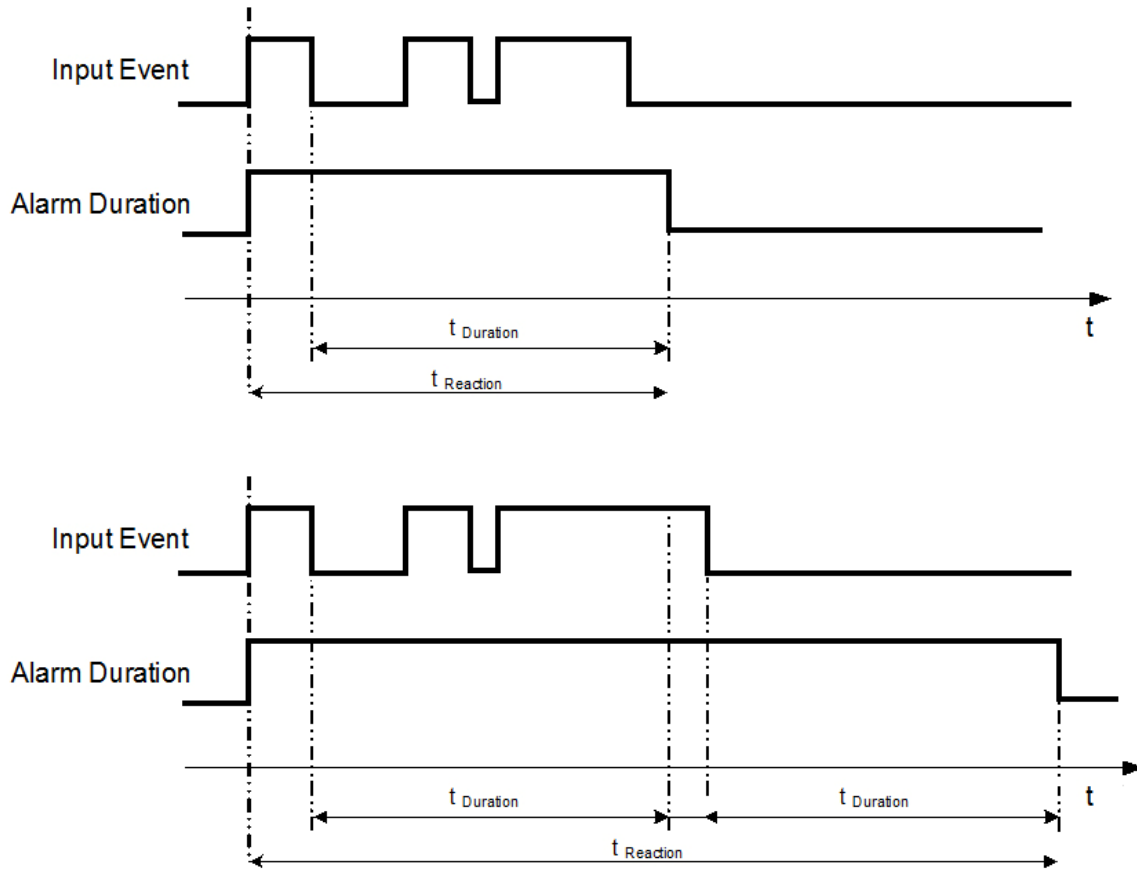

$t_{\text{Event}}$ : Duration of alarm input source (motion, contact, system events...)

$t_{\text{Duration}}$ : Alarm duration for timeout, defined in the event setup menus

$t_{\text{reaction}}$ : Resulting duration for this alarm mode, related to event record, alarm outputs, OSD message, buzzer

## Appendix B: Control Protocol

### 1-1. PC to DVR Connection

This Digital Video Recorder may be controlled by a computer using a 232-to-485 converter. Refer to the following picture to make the proper connections from your PC to the DVR.

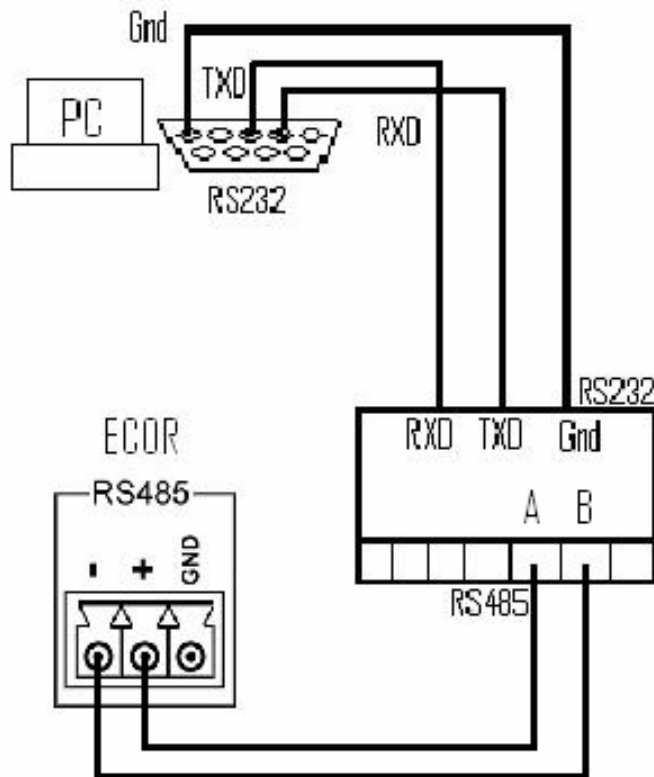

## 2-1. Packet Format:

Commands should be sent in packets using the following command string:

Length Byte  
Receiver ID high byte  
Receiver ID low byte  
Opcode Byte  
Data Byte  
Checksum Byte

## 2-2. Length Byte

This Length Byte is a prefix.

EX: 0x85 ==> this packet contains 5 bytes. (not including Length byte)

## 2-3. Receiver ID

ID number can be found by converting the ID in the DVR's Control Menu to hexadecimal.

Receiver ID (in Decimal)	16bit binary value	High byte	Low byte
0	00000000 00000000	00	00
1	00000000 00000001	00	01
2	00000000 00000010	00	02
...			
127	00000000 01111111	00	7F
128	00000000 10000000	00	80
...			
255	00000000 11111111	00	FF
256	00000001 00000000	01	00
...			
511	00000001 11111111	01	FF
512	00000010 00000000	02	00
...			
16382	00111111 11111110	3F	FE



## 2-4. Opcode Byte & Data bytes

### 2-4-1. OPcode

0x4B : A remote key pressed

### 2-4-2. Code functions for "Remote key pressed"

0x00	CH1	0x1c	>>>
0x01	CH2	0x1d	>>>
0x02	CH3	0x1e	(reserve)
0x03	CH4	0x1f	(reserve)
0x04	VIEW	0x20	CH5
0x05	ZOOM	0x21	CH6
0x06	SEQ	0x22	CH7
0x07	MENU	0x23	CH8
0x08	(reserve)	0x24	CH9
0x09	(reserve)	0x25	(reserve)
0x0A	LIVE	0x26	(reserve)
0x0B	PLAY	0x27	(reserve)
0x0C	PAUSE	0x28	(reserve)
0x0D	SEARCH	0x29	(reserve)
0x0E	COPY	0x2a	(reserve)
0x0F	DISPLAY	0x2b	(reserve)
0x10	<< (x2)	0x2c	(reserve)
0x11	<< (x4)	0x2d	(reserve)
0x12	<< (x8)	0x2e	ENTER
0x13	<< (x16)	0x2f	ARROW UP
0x14	<< (x32)	0x30	ARROW DOWN
0x15	<<<	0x31	ARROW LEFT
0x16	<<<	0x32	ARROW RIGHT
0x17	>> (x2)	0x33	FAST REVERSE
0x18	>> (x4)	0x34	PLAY/PAUSE
0x19	>> (x8)	0x35	FAST FORWARD
0x1a	>> (x16)	0x36	(reserved)
0x1b	>> (x32)	0x37	STEP REVERSE

## 2-5. Checksum Byte

Checksum is found by taking the sum of all previous bytes (including the length byte) and using mask of 0x7f. For help with computing the Checksum Byte, use the EverFocus Checksum Calculator or Serial Comm programs, found at the following link:

<ftp://208.50.31.200/Checksum%20Calculator/>

## 3-1. Sample control code packets

Example1: A packet that send "MENU" key to ECOR (ID=5)

0x85 (length)  
0x00 (Receiver ID high byte)  
0x05 (Receiver ID low byte)  
0x4B (OPcode = key)  
0x07 (DATA1 = "Menu" keycode)  
0x5C (checksum)

Example2: A packet that send "PLAY" key to ECOR (ID=4999)

0x85 (length)  
0x13 (Receiver ID high byte)  
0x87 (Receiver ID low byte)  
0x4B (OPcode = key )  
0x0B (DATA1 = "Play" keycode )  
0x75 (checksum)

## **EverFocus Electronics Corp.**

### **Headquarter Office**

12F, No.79 Sec.1 Shin-Tai Wu Road,  
Hsi-Chi, Taipei, Taiwan  
Tel: +886-2-26982334  
Fax: +886-2-26982380

### **Beijing office**

Room 609, Technology Trade Building.  
Shangdi Information Industry Base,  
Haidian District, Beijing China  
Tel: +86-10-62971096  
Fax: +86-10-62971423

### **European Office**

Albert-Einstein-Strasse 1,  
D-46446 Emmerich, Germany  
Tel: +49-2822-9394-0  
Fax: +49-2822-939495

### **Japan Office**

1809 WBG Marive East 18F,  
2-6 Nakase, Mihama-ku,  
Chiba city 261-7118, Japan  
Tel: +81-43-212-8188  
Fax: +81-43-297-0081

### **USA California Office**

1801 Highland Ave. Unit A  
Duarte, CA 91010 ,U.S.A  
Tel: +1-626-844-8888  
Fax: +1-626-844-8838

### **USA New York Office**

415 Oser Ave Unit S  
Hauppauge, NY 11788  
Sales: +1-631-436-5070  
Fax: +1-631-436-5027



Your EverFocus product is designed and manufactured with high quality materials and components which can be recycled and reused. This symbol means that electrical and electronic equipment, at their end-of-life, should be disposed of separately from your household waste. Please, dispose of this equipment at your local community waste collection/recycling centre. In the European Union there are separate collection systems for used electrical and electronic product. Please, help us to conserve the environment we live in!

Ihr EverFocus Produkt wurde entwickelt und hergestellt mit qualitativ hochwertigen Materialien und Komponenten, die recycelt und wieder verwendet werden können. Dieses Symbol bedeutet, dass elektrische und elektronische Geräte am Ende ihrer Nutzungsdauer vom Hausmüll getrennt entsorgt werden sollen. Bitte entsorgen Sie dieses Gerät bei Ihrer örtlichen kommunalen Sammelstelle oder im Recycling Centre. Helfen Sie uns bitte, die Umwelt zu erhalten, in der wir leben!



**EverFocus®**

P/N: MCORG00200\_Ver.A