



Instruction Manual



EDR1640/1620/920

EVERFOCUS ELECTRONICS CORPORATION

EDR1640 / 1620 / 920

Instruction Guide

© 2005 EverFocus Electronics Corp
www.everfocus.com

All rights reserved. No part of the contents of this manual may be reproduced or transmitted in any form or by any means without written permission of the Everfocus Electronics Corporation.

Release Date: April 2009

QuickTime is a registered trademark of the Apple Computer, Inc.

Windows is a registered trademark of the Microsoft Corporation.

Linksys is a registered trademark of the Linksys Corporation.

D-Link is a registered trademark of the D-Link Corporation.

DynDNS is a registered trademark of the DynDNS.org Corporation.

Other product and company names mentioned herein may be the trademarks of their respective owners.

Federal Communication Commission Interference Statement

This equipment has been tested and found to comply with the limits for a Class B digital device, pursuant to Part 15 of the FCC Rules. These limits are designed to provide reasonable protection against harmful interference in a residential installation. This equipment generates, uses and can radiate radio frequency energy and, if not installed and used in accordance with the instructions, may cause harmful interference to radio communications. However, there is no guarantee that interference will not occur in a particular installation. If this equipment does cause harmful interference to radio or television reception, which can be determined by turning the equipment off and on, the user is encouraged to try to correct the interference by one of the following measures :

- Reorient or relocate the receiving antenna.
- Increase the separation between the equipment and receiver.
- Connect the equipment into an outlet on a circuit different from that to which the receiver is connected.
- Consult the dealer or an experienced radio/TV technician for help. FCC Caution: Any changes or modifications not expressly approved by the party responsible for compliance could void the users' authority to operate this equipment. This device complies with Part 15 of the FCC Rules. Operation is subject to the following two conditions: (1) This device may not cause harmful interference, and (2) this device must accept any interference received, including interference that may cause undesired operation.

This device and its antenna(s) must not be co-located or operating in conjunction with any other antenna or transmitter.

CE Declaration

This equipment has been tested and found to comply with the limits for a **CE Class B** digital device,

The changes or modifications not expressly approved by the party responsible for compliance could void the user's authority to operate the equipment.

In a domestic environment this product may cause radio interference. In which case the user may be required to take adequate measures.

Non-LPS or TNV output connectors identify the type of circuit, intended cable type or relevant circuit characteristics. (Marking or Instruction)

“**CATUION: Risk of Explosion if Battery is replaced by an Incorrect Type. Dispose of Used Batteries According to the Instructions.**”



TABLE OF CONTENTS

1.	PRODUCT OVERVIEW	1
1.1	FEATURES.....	1
1.2	SPECIFICATIONS.....	2
1.3	FRONT PANEL KEYPADS.....	4
1.4	BACK PANEL CONNECTIONS.....	7
1.5	MONITOR DISPLAY.....	10
2.	INSTALLATION.....	13
2.1	VIDEO CONNECTIONS, DVR CASCADING.....	14
2.2	AUDIO CONNECTION INSTALLATION	16
2.3	SPEED DOME INSTALLATION	17
2.4	ALARM INPUT / OUTPUT INSTALLATION.....	18
2.5	EDA800s INSTALLATION (OPTIONAL).....	21
2.6	NETWORK CONNECTION.....	21
2.6.1.	<i>Direct PC connection through crossover network cable.....</i>	<i>21</i>
2.6.2.	<i>Network connection through patch cable.....</i>	<i>22</i>
2.6.3.	<i>Network system requirements.....</i>	<i>22</i>
2.7	HARD DISK DRIVE INSTALLATION.....	22
2.8	FINAL INSTALL PROCESS	23
3.	DVR MENU SETUP.....	24
3.1	TIME/DATE SETUP MENU	25
3.2	CAMERA SETUP MENU	29
3.3	RECORD SETUP MENU	33
3.4	ALARM SETUP MENU	35
3.5	MOTION SETUP MENU	38
3.6	VIDEOLOSS SETUP MENU	41
3.7	NETWORK SETUP MENU	43
3.7.1	<i>CONFIG.....</i>	<i>43</i>
3.7.2	<i>ALARM (NETWORK).....</i>	<i>45</i>
3.7.3	<i>EMAIL.....</i>	<i>46</i>
3.7.4	<i>PASSWORD.....</i>	<i>47</i>
3.7.5	<i>PPPOE.....</i>	<i>48</i>
3.7.6	<i>DDNS.....</i>	<i>49</i>
3.8	SCHEDULE SETUP MENU	51
3.9	DISK SETUP MENU	53
3.10	CONTROL SETUP MENU	55
3.11	WARNING SETUP MENU.....	57
3.11.1	<i>FAN FAULT.....</i>	<i>57</i>
3.11.2	<i>HDD TEMP.....</i>	<i>58</i>
3.11.3	<i>NO HDD.....</i>	<i>60</i>

3.11.4	HDD FULL.....	61
3.12	SYSTEM SETUP MENU.....	63
4.	RECORDING OVERVIEW.....	66
4.1	INSTANT (N) RECORDING SETUP.....	66
4.2	SCHEDULE RECORDING SETUP.....	67
4.3	EVENT RECORDING SETUP.....	67
4.4	ALARM INPUT RECORDING (INPUT TRIGGER).....	69
5.	PLAYBACK OVERVIEW.....	70
5.1	BASIC PLAYBACK.....	70
5.2	SEARCH PLAYBACK.....	71
6.	COPYING VIDEO.....	75
6.1	VIEWING A COPIED FILE.....	77
7.	CALL OVERVIEW.....	78
8.	SCREEN DISPLAY SETTING & MODE.....	80
8.1	MODE BUTTON.....	82
9.	FIRMWARE UPGRADE.....	83
10.	NETWORKING OVERVIEW.....	84
10.1	INTRODUCTION TO TCP/IP.....	84
10.2	SUBNET MASKS.....	84
10.3	GATEWAY ADDRESS.....	84
10.4	VIRTUAL PORTS.....	85
10.5	PRE-INSTALLATION.....	85
10.6	WHAT TYPE OF NETWORK CONNECTION DO YOU HAVE?.....	87
10.7	SIMPLE ONE TO ONE CONNECTION.....	87
10.8	DIRECT HIGH SPEED MODEM CONNECTION.....	96
10.9	ROUTER OR LAN CONNECTION.....	98
11.	LINKSYS PORT FORWARDING.....	101
12.	D-LINK PORT FORWARDING.....	105
13.	EVERFOCUS DDNS SETUP.....	108
14.	VIEWING THROUGH INTERNET EXPLORER.....	110
14.1	SEARCH.....	119
14.1.1	Search by TIME.....	119
14.1.2	Search by EVENT.....	120
14.2	PTZ CONTROL.....	121
14.3	REMOTE ARCHIVE.....	122
14.4	REMOTE CONFIGURATION.....	126
15.	INTERFACE SPECIFICATIONS.....	133

15.1	TRANSMISSION SETTING	133
15.2	REMOTE CONTROL PROTOCOL.....	134
APPENDIX A: REMOTE CONTROL.....		139
APPENDIX B: MOUSE INSTALLATION		140
APPENDIX C: ALARM BOARD CONFIGURATION		143
APPENDIX D: LAPSE MODE RECORDING TABLE.....		144
TROUBLESHOOTING		151

Safety Warning

WARNING

TO REDUCE RISK OF FIRE OR ELECTRIC SHOCK,
DO NOT EXPOSE THIS APPLIANCE TO RAIN OR MOISTURE.

Note:

This is a class A product. In a domestic environment this product may cause radio interference, in which case the user may be required to take adequate measures.

Notice:

The information in this manual was current when published.
The manufacturer reserves the right to revise and improve its products.
All specifications are therefore subject to change without notice.

Safety Precautions (1)

- Refer all work related to the installation of this product to qualified service personnel or system installers.
- Do not block the ventilation opening or slots on the cover.
- Do not drop metallic parts through slots. This could permanently damage the appliance. If this does happen, turn the power off immediately and contact qualified service personnel for service.
- Do not attempt to disassemble the appliance. There are no user-serviceable parts inside. To prevent electric shock, do not remove screws or covers. If service is required, contact qualified service personnel for maintenance. Handle the appliance with care. Do not strike or shake, as this may damage the appliance.
- Do not expose the appliance to water or moisture, nor try to operate it in wet areas. Take immediate action if the appliance becomes wet. If this does happen, turn the power off and refer servicing to qualified service personnel. Moisture may damage the appliance and also cause electric shock.
- Do not use strong or abrasive detergents when cleaning the appliance body. Use a dry cloth to clean the appliance when it is dirty. When the dirt is hard to remove, use a mild detergent and wipe gently.
- Do not overload outlets and extension cords as this may result in a risk of fire or electric shock.
- Do not operate the appliance beyond its specified temperature, humidity or power source ratings. Do not use the appliance in an extreme environment where high temperature or high humidity exists. Use the appliance at temperature within indoor type DVR for 32°F ~ 104°F and a humidity below 90%. The input power source for this appliance is AC100~240V.

Safety Precautions (2)

Read Instructions — All the safety and operating instructions should be read before the unit is operated.

Retain Instructions — The safety and operating instructions should be retained for future reference.

Warnings — All warnings on the unit and in the operating instructions should be adhered to.

Follow Instructions — All operating and user instructions should be followed.

Cleaning — Unplug the unit from the outlet before cleaning. Do not use liquid cleaners or aerosol cleaners. Use a damp cloth for cleaning.

Water and Moisture — Do not use this unit near water—for example, near a bath tub, wash bowl, kitchen sink, or laundry tub, in a wet basement, near a swimming pool, in an unprotected outdoor installation, or any area which is classified as a wet location.

Servicing — Do not attempt to service this unit by yourself as opening or removing covers may expose you to dangerous voltage or other hazards. Refer all servicing to qualified service personnel.

Power Cord Protection — Power supply cords should be routed so that they are not likely to be walked on or pinched by items placed upon or against them, paying particular attention to cords and plugs, convenience receptacles, and the point where they exit from the appliance.

Object and Liquid Entry — Never push objects of any kind into this unit through openings as they may touch dangerous voltage points or short-out parts that could result in a fire or electric shock. Never spill liquid of any kind on the unit.

1. Product Overview

The EDR1640/1620/920 DVR's are the industry's first full-featured digital video recorder designed specifically for use within the CCTV security industry. EDR1640/1620/920 DVR's incorporates all the benefits of digital video recording, is simple to install, and operates just like a VCR. Highly efficient compression technology and superior resolution of recorded images make the Digital Video Recorder stand out from the competition as the best choice for security surveillance.

1.1 Features

- Multiplex Operation (Recording, Playback, Archiving, Remote Viewing)
- Built-in MPEG4 Codec with Configurable Quality
- Embedded Linux OS
- Variable Recording Speeds Up to 480 (EDR1640)/240 (EDR1620, 920) images per second
- 4-channel Audio Recording Capabilities (local)
- Motion Detection Capabilities
- Two 3.5" Hot-Swap Hard Disks, expendable to max. 50 Hard Disks with EDA800S (optional)
- SCSI Interface for External Expanded Storage
- Ethernet Interface for Remote Network Viewing and Controlling
- RS232/RS485 for Remote Control
- Shuttle/Jog Dial for Picture-by-Picture or Fast/Slow Viewing
- Easy-to-use User Friendly Control via front panel keypad, Shuttle/Jog, Mouse and Control Keyboard (optional)
- On-Screen Menus Operations with Multi-Language Support
- Real-Time Live Display for all Cameras
- USB 2.0 Interface for Archiving
- Support external USB DVD+RW for archiving (optional)
- Water Mark Capabilities
- Remote configuration function
- Remote Firmware Upgrade function
- Motion detection function can be scheduled according to user's setting

1.2 Specifications

Video Format	NTSC or PAL
Video Input	16 / 9 BNC camera inputs (1Vp-p/75ohm)
Video Output	1 BNC video out (1Vp-p/75ohm) for Main Monitor 1 S-Video output for Main Monitor 1 BNC video out (1Vp-p/75ohm) for Call Monitor 16 / 9 BNC video out (1Vp-p/75ohm) for Looping
Video Compression	MPEG4
EDR1640 Recording Resolution	720x480 (NTSC:120IPS) / 720x576 (PAL:100IPS) 720x240 (NTSC:240IPS) / 720x288 (PAL:200IPS) 360x240 (NTSC:480IPS) / 360x288 (PAL:400IPS)
EDR1620 Recording Resolution	720x480 (NTSC: 60 IPS) / 720x576 (PAL: 50IPS) 720x240 (NTSC:120IPS) / 720x288 (PAL:100IPS) 360x240 (NTSC:240IPS) / 360x288 (PAL: 200IPS)
EDR920 Recording Resolution	720x480 (NTSC: 60 IPS) / 720x576 (PAL: 50IPS) 720x240 (NTSC:120IPS) / 720x288 (PAL:100IPS) 360x240 (NTSC:240IPS) / 360x288 (PAL: 200IPS)
Video Display	Full, 4, 7, 9, 10, 13, and 16 views for Live and Playback PIP and 2x2 Zoom for Live only
Video Pause	Yes
Alarm Inputs	16/9 Alarm Inputs
Alarm Outputs	4 Alarm Outputs
Hard Disk Storage	Two Hot-Swappable 3.5" IDE Hard Disk
Recording Rate	1640: Up to 480 IPS for NTSC (400 IPS for PAL) 1620/920: Up to 240 IPS for NTSC (200 IPS for PAL)
Recording Mode	Continuous, Schedule, Event (Motion and Alarm) recording
Playback Rate	Up to 60/50 Images per second for NTSC/PAL
Playback Search	By Date/Time or Event (Motion, Video Loss, Alarm)
Motion Detection	Yes, with configurable detection areas & sensitivity
Video Loss Detection	Yes
Event Log	Yes
Setup	Menu Driven On Screen Display
User Input Device	Front panel keypad with Shuttle/Jog Wheel, IR Remote Control, PS/2 Mouse (optional), EKB500 (optional)
Timer	Built-in real time clock with time synchronization through NTP Server
Watch Dog Timer	Yes
Title	12-character title for each camera
Ethernet	RJ45 connector for 10/100 Mbps network communication
Archive	USB 2.0 Interface Device for archiving

RS-232	9-pin female connector for testing purposes	
RS-485	For Keyboard and PTZ connection	
Audio	4 mono inputs, 1 mono (SPEAKER) output	
Power Source	AC100~240	
Power Consumption	60W	
Dimension	430 (W) x 88 (H) x 300 (D) mm / 17" (W) x 3.5" (H) x 12" (D)	
Weight	6.24 kg (approx. 13.7 lbs)	
Operating Temperature	0°C ~ +40°C / 32°F ~104°F	
Recording Rate	NTSC	PAL
1640 model	D1 720x480 : 120 IPS Half D1 720x240 : 240 IPS CIF 360x240 : 480 IPS	D1 720x576 : 100 IPS Half D1 720x288 : 200 IPS CIF 360x288 : 400 IPS
1620 model	D1 720x480 : 60 IPS Half D1 720x240 : 120 IPS CIF 360x240 : 240 IPS	D1 720x576 : 50 IPS Half D1 720x288 : 100 IPS CIF 360x288 : 200 IPS
920 model	D1 720x480 : 60 IPS Half D1 720x240 : 120 IPS CIF 360x240 : 240 IPS	D1 720x576 : 50 IPS Half D1 720x288 : 100 IPS CIF 360x288 : 200 IPS

1.3 Front Panel Keypads

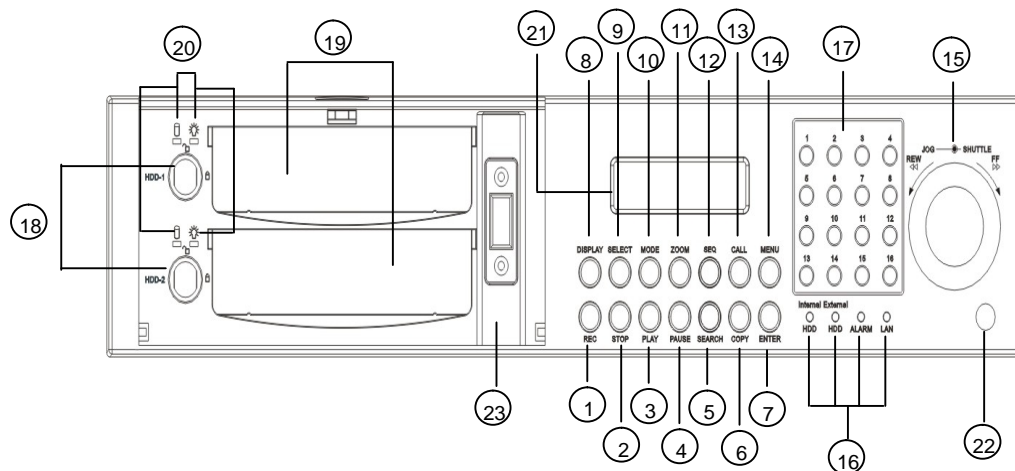

Keys:

1. **REC:** Press this key to start instant recording.
2. **STOP:** Press this key to stop recording and playing back.
3. **PLAY:** Press this key to start playing back.
4. **PAUSE:** Press this key to pause the playback picture.
5. **SEARCH:** Press this key to enter the **SEARCH MENU**.
6. **COPY:** Press this key to enter the **Copy Menu**.
7. **ENTER:** Press this key to enter items or jump to next subentry in the menu setting.
8. **DISPLAY:** Press this key to cycle through the display of channels and/or status bar.

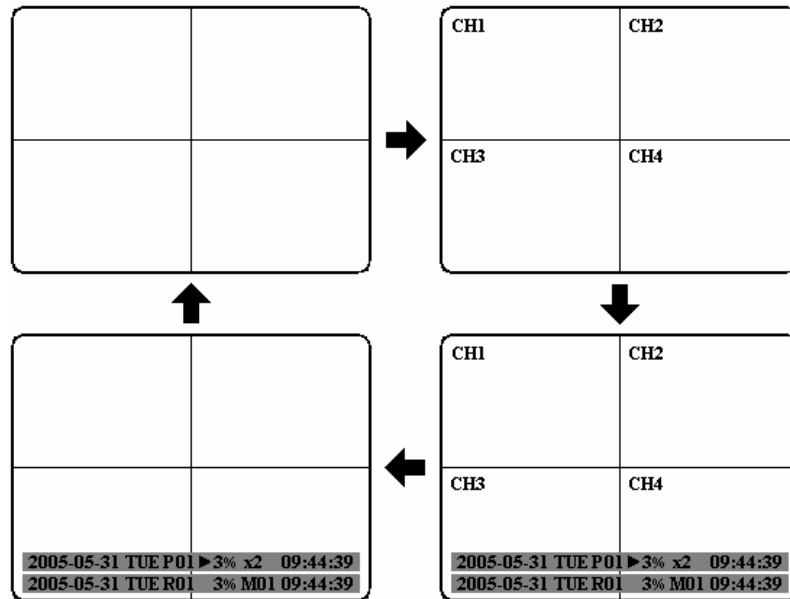

9. SELECT: On live view, press this key to assign a camera to a multi-screen or to adjust single screen display properties. In menus, press this key to select certain features.

10. MODE: Switch PIP, 4, 7, 9, 10, 13 and 16 displays in **Live** and **Playback**

11. ZOOM: In full screen mode, 2x electronic zoom. Zoom screen can be moved through **JOG**. **ENTER** key changes the scroll direction between horizontal and vertical. Pressing the zoom key again switches the electronic zoom off.

In multiscreen mode: Image orientation adjustment. Use the **JOG** to adjust the image to the monitor type. **ENTER** switches between horizontal and vertical adjustment. Press the zoom key again to exit screen adjustment.

12. SEQ: Press this key to enter the auto sequential switching mode.

13. CALL: Press this key to enter and set up **CALL MENU**.

14. MENU: Press this key to enter/exit the Main Menu or to exit from any submenu.

15. Shuttle and Jog Dial

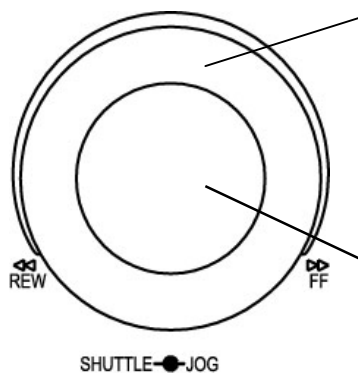

Shuttle:

In the **Playback** mode, turn the **Shuttle** dial to fast forward/rewind the video.

In the **Pause** mode, turn the **Shuttle** dial to slow forward/rewind the video.

In the event list, turn the **Shuttle** to change pages.

Jog Dial:

In the **Pause** mode, turn the **Jog** dial to forward/rewind the video frame by frame. In the **Menu** mode, turn the **Jog** dial to change settings and values in subentries.

16. System LEDs

LEDs for system active **HDD**, **ALARM** and **LAN** display.

17. Channel Key (1~16)

Press channel key (**CH1~CH16**) to display that channel in full screen view.

18. HDD LOCK

Turn on HDD power and prevent HDD theft.

19. Hard Disk Tray

Hard Disk holder for HDD.

20. HDD LED's

LED's for HDD active power (GREEN) and data reading/writing (RED).

21. LCD Panel

To display Date and Time, and other system information.

22. IR receiver

Receiver for optional infrared remote control.

23. USB slot

USB port allows you to archive video files to USB device.

1.4 Back Panel Connections

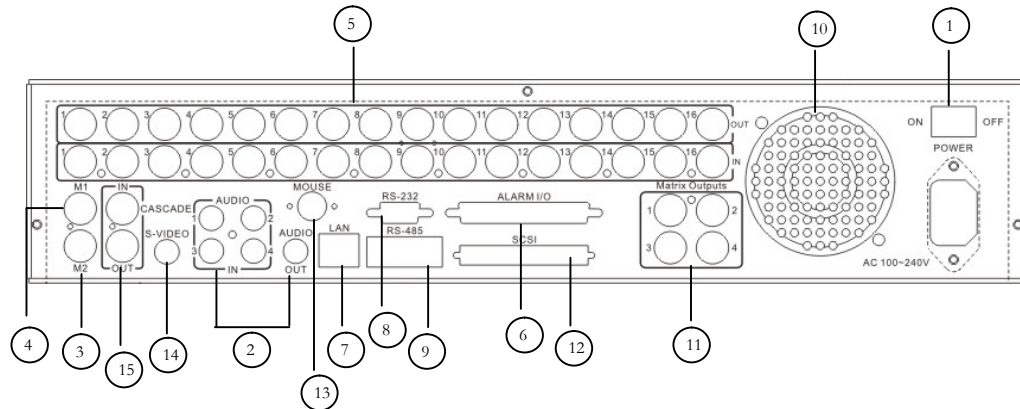

POWER

- ① **Main Power plug:** power source to AC 100~ 240V.

AUDIO

- ② **Audio IN:** Audio inputs 1~4 for recording, and it can be set to “**YES**” or “**NO**” in the **RECORD SETUP MENU**.
Audio OUT: Connect an audio output to a monitor or other device.

MONITOR

- ③ **MAIN MONITOR:** This connector is used for the main monitor display, a number of different display modes may be selected for viewing.
- ④ **CALL MONITOR:** This connector is used for the call monitor. This monitor can only display a full screen.

VIDEO IN

- ⑤ **For EDR1640/1620 Series:**
VIDEO OUT(1~16): Top row BNC connectors for video looping out 1~16.
VIDEO IN(1~16): Bottom row BNC connectors for video input 1~16 .

For EDR920 Series:

VIDEO OUT(1~9): Top row BNC connectors for video looping out 1~9.

VIDEO IN(1~9): Bottom row BNC connectors for video input 1~9 .

Alarm Input/Output

⑥ **Alarm Input**

ALM-INPUT: Normal open or normal close type alarm signal inputs.

The Alarm Input can be selected as normal open (**N.O.**) or normal close (**N.C.**) input in the **ALARM SETUP MENU**. When an alarm occurs, alarm recording will automatically start.

ALM-OUTPUT: A built-in relay offers 3 nodes which are **ALM-COM** (common), **ALM-NO** (normal open) and **ALM-NC** (normal close) for external use.

Note: Please check Chapter 3.4 and **APPENDIX C** to see other available alarm input/output functions.

LAN

⑦ **LAN Connector:** The RJ-45 network connection.

RS232

⑧ **RS232 connector:** D-Sub 9 pin connector for testing purposes only.

RS485

⑨ **RS485 connector:** RJ 45 Connector for RS485 control (via EKB500 controller) and for multi Digital Video Recorder cascade.

FAN

⑩ **FAN:** Cooling FAN.

Matrix Outputs

- ⑪ **Matrix outputs 1~4:** BNC connectors for Matrix monitor outputs 1~4.

SCSI Connector

- ⑫ **SCSI Connector:** For connecting the optional EDA800 storage expansion.

Mouse

- ⑬ **Mouse:** PS/2 connector for mouse input.

S-Video

- ⑭ **S-Video:** PS/2 connector for S-Video monitor output.

Cascade

- ⑮ **Cascade** is designed for connecting a number of DVRs to one monitor. You will be allowed to view and to control as many DVRs as you prefer from the same monitor simply switching the screen using a multi-function keyboard controller.

Connect from **Cascade out** of the DVR to Cascade In of another with BNC connectors. Repeat the same step for all your DVRs until you connect the last Cascade Out to the original DVR's **Cascade In**.

1.5 Monitor Display

The status information of the cameras or machine will show up, and be located at different places on the screen.

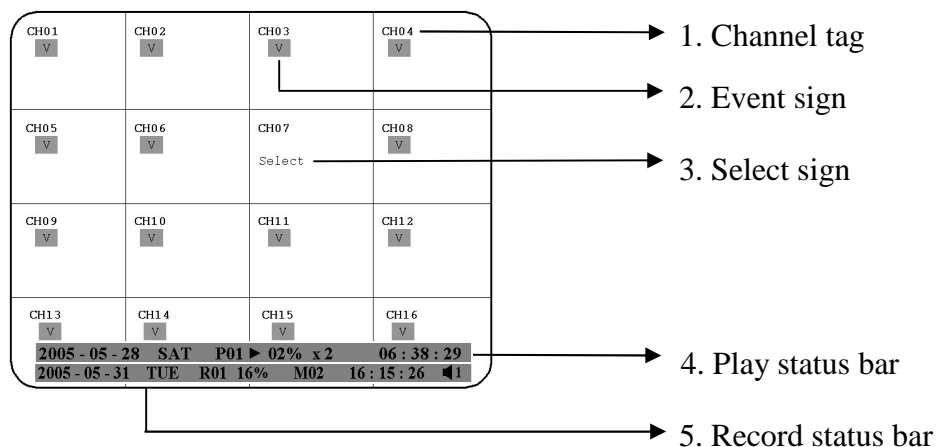

1. Channel tag: A channel tag indicates the channel name of the screen.

2. Event sign: Event signals which are small icons with a capital letter and red background show the events on each screen. There are a total of 6 different signals:

- A** Alarm event. In order to show the camera video to a corresponding alarm, setting a **FOCUS CAMERA** in **ALARM SETUP MENU** is necessary.
- M** Motion event. Motion event only shows up when the camera's **MOTION** is enabled in **MOTION SETUP MENU**, and the camera detects a motion.
- V** Video loss event. Video loss event only shows when the camera's **VIDEOLOSS** is enabled in **VIDEOLOSS SETUP MENU**, and the camera signal is lost.
- S** Sequence sign. Sequence sign shows up when the display is in the sequence mode. The last display on the screen has a "*" sign in the top-middle. The **s** sign will replace the "*" in the display when sequence occurs.

Note: Sequence is invalid when all cameras are showing.

T Temperature indication. This shows if the hard drive's temperature is overheated. Overheat is determined in **HDD TEMPERATURE** of **WARNING SETUP MENU**.

F Fan fail indication. This shows when the fan fails to work normally. If you get this warning, contact technical support for assistance.

3. Select sign: You can assign a camera to a display by pressing **SELECT** key in live mode. Dial **Jog** to move the select sign to the display you would like to change camera, and then press channel key on the front panel to choose that channel. Press **SELECT** again to exit from this mode.

4. Play status bar: The play status bar appears in play back mode if you enable a status bar on the screen (Please see **DISPLAY**, 8th item of **Front Panel Keypads**). There are three parts that will be shown: **play date**, **play status**, and **play time**.



Play date

The date on which the video was recorded.

Play status

- “PAUSE”, when the video playback is paused.
- “P## >” means normal play speed on the displayed disk number;
- “P## <” means normal reverse play speed on the displayed disk number;
- “>> x N” means N time fast play speed;
- “<< x N” means N time fast reverse play speed.

Play time

The play time at which the video is recorded. The time format depends on the time format setting in the **TIME/DATE SETUP MENU**.

5. Record status bar

The record status bar appears when you enable a status bar on the screen.

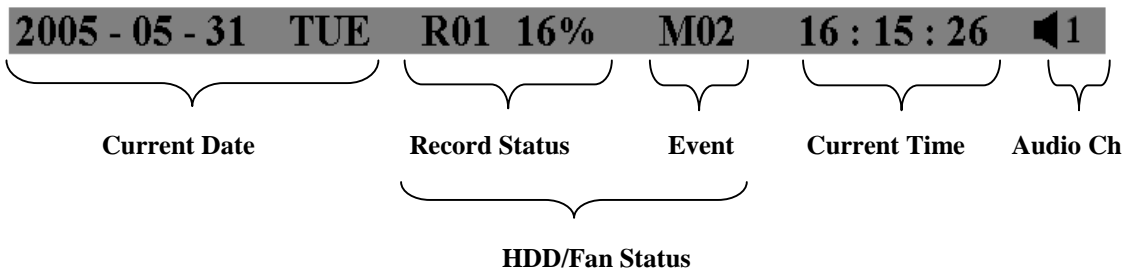

1. **Current date**
The current date which is set in the **TIME/DATE SETUP MENU**.
2. **Record status**
Displays current Hard Drive and record position.
R01: currently recording on Disk 1
16%: currently recording at 16% of total HD position
***NOTE:** Percentage only indicates the physical point of recording on the Hard Drive, not the total disk space used. To review the total amount of recording time, please refer to the Disk Menu (Chapter 3.9)*
3. **Event**
The current/last event that occurred.
4. **Current time**
The current time which is set in the **TIME/DATE SETUP MENU**.
5. **Audio Ch**
Displays which audio channel is currently active. This can be changed by turning the Jog wheel in the live camera mode.
6. **HDD/Fan status**
“**No Disk**”: only shows when no disk is installed or detected.
“**No Fan**”: only shows when internal fan stops working.
“**HDD OT**”: only shows if hard drive is over temperature.

2. Installation

The installations described below should be made by qualified service personnel or system installers. Please check accessories in the packaging before beginning installation. Please refer to the following diagram for the basic wiring connections.

Note: Monitors and Cameras must be purchased separately.

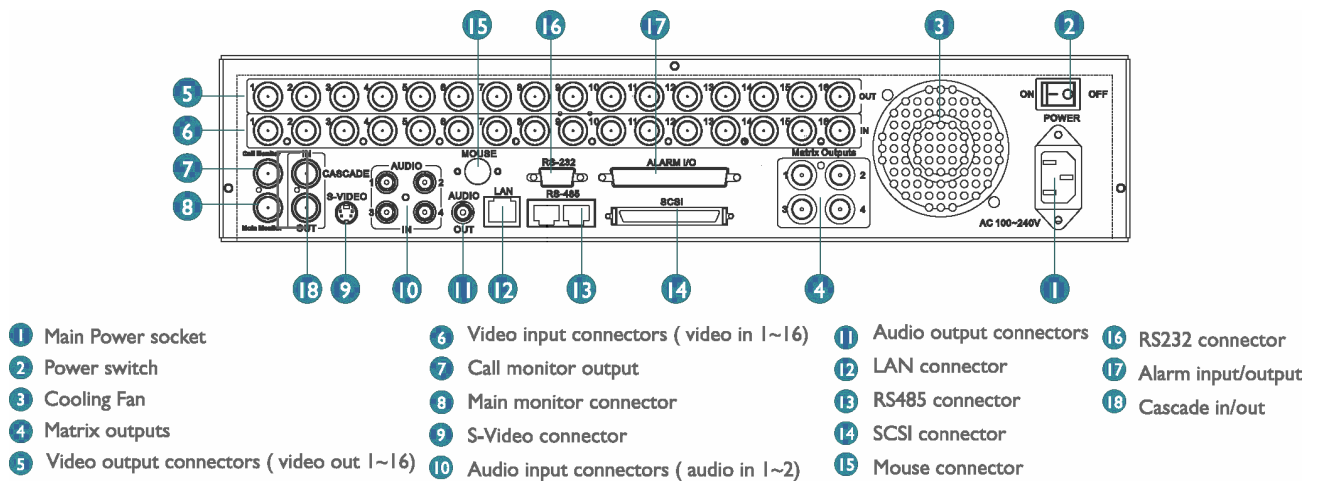

Diagram 2.1

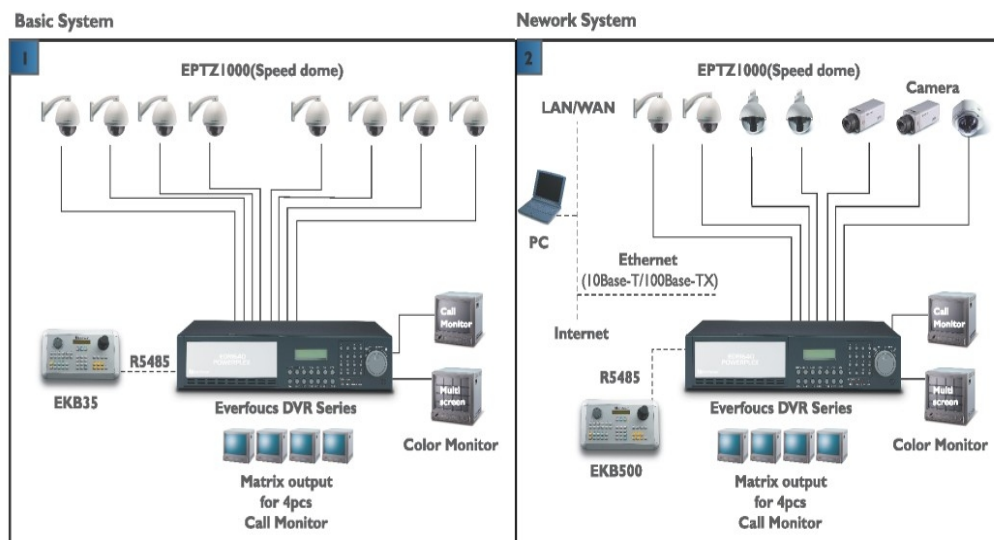

Diagram 2.2

2.1 Video Connections, DVR cascading

Sample installation with maximum camera and monitor configuration:

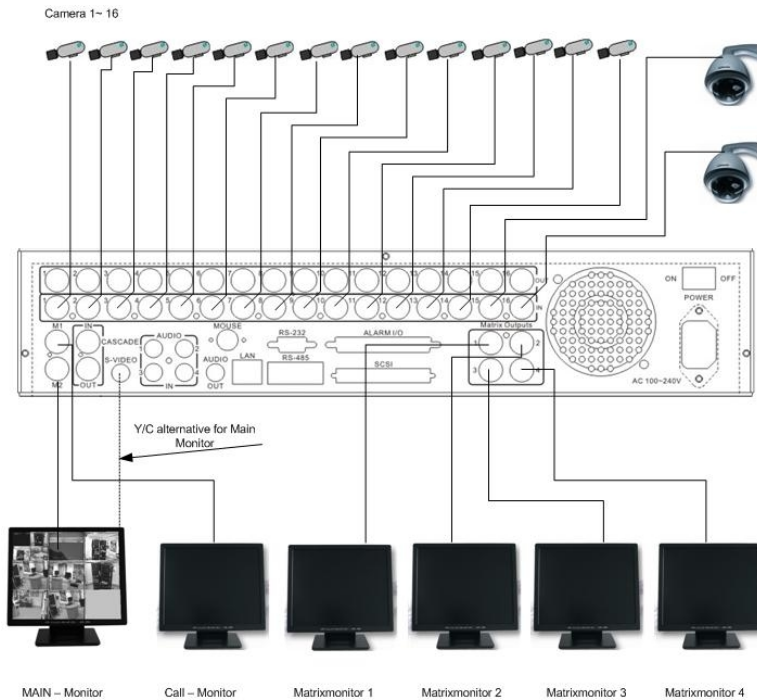

Diagram 2.3

Cameras and monitors have to be cabled with 75 Ohm video cable, e.g. RG-59, RG-6, RG-11 and suitable BNC plugs.

Due to inappropriate absorbability, 50 Ohm coax cable (e.g. RG58), antenna cable and further types of coax cable are not suitable.

All connected video sources must provide a 1 Vpp NTSC standard video signal.

When interconnecting transmission lines (twisted pair, fibre optics, radio) to the video inputs, ensure the accurate receiver calibration.

The MAIN monitor may optionally be connected through a Y-C (S-Video) cable to achieve an improved image quality.

For local DVR operation, MAIN monitor connection is compulsory. Call and matrix monitors can be connected optionally.

ATTENTION: Make sure that there is a video signal on video input 1 upon start-up, as this input is required for video system auto detection (NTSC/PAL)!

DVR Cascading

The digital video recorders provide "CASCADE IN" and "CASCADE OUT" video connections.

In combination with EKB500 keyboard, up to 255 EDR1640/1620/920 can be cascaded and administrated via one single main monitor. Cascading is effected by connecting the DVRs "CASCADE OUT" to the "CASCADE IN" of the following DVR, while the last "CASCADE OUT" is connected to the monitor input.

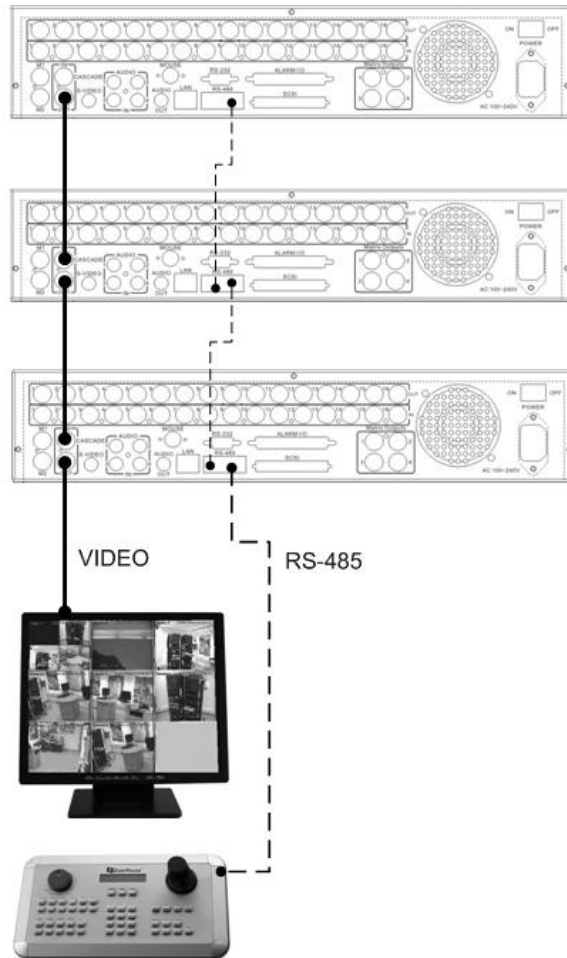

Diagram 2.4

Installation with 3 cascaded EDR and EKB-500

2.2 Audio Connection Installation

Sample installation with audio connection to video cameras providing audio output:

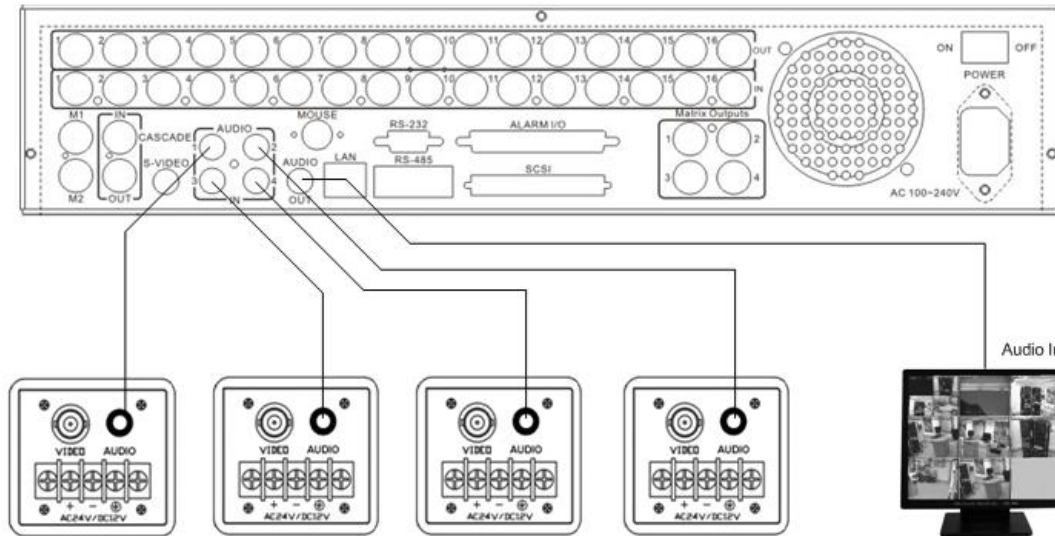

Diagram 2.5

The EDR1640/1620/920 DVRs provide 4 audio inputs and 1 audio output.

The inputs are designed for max. 500 mV to 10 KOhm line audio signals.

ATTENTION: The direct connection of a non-amplified microphone is not supported (a microphone amplifier is required).

The installation has to be effected with audio coax cable and RCA plugs.

The output provides a max. 500 mV to 10 KOhm line audio signal and may be connected to e.g. a monitor's audio input. The direct connection of (passive) speakers is not supported.

AUDIO RECORDING FUNCTIONALITY:

Audio recording is activated / deactivated in the RECORD menu for all channels.

Audio of all channels is always recorded together with (each) video and is independent of the image recording rate. There is no specific camera allocation.

During playback, use the JOG to select the requested playback channel 1~4 (active channel is indicated in playback on-screen display).

2.3 Speed Dome Installation

Speed dome or telemetry receiver pan/tilt/zoom control is available through web browser or the optional PowerCon software if the DVR is connected to a network. Local telemetry control is provided by the optional EKB 500 keyboard.

Supported protocols: EverFocus, Pelco-D, Pelco-P, ED2200/2250

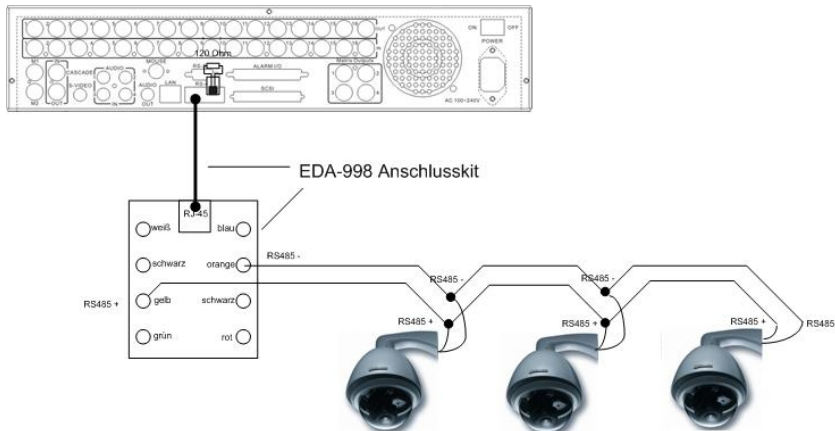

Diagram 2.6

Sample installation with 3 EPTZ1000 speed domes and EDA998

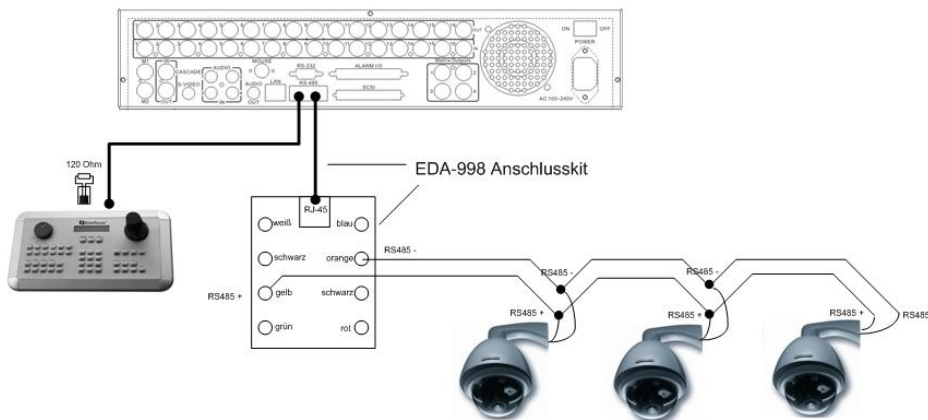

Diagram 2.7

Sample installation with 3 EPTZ1000 speed dome, EDA998 and local EKB 500 operation

Required DVR settings: RS-485 receiver address in **CAMERA** menu; RS-485 parameters and protocol in **CONTROL** menu

ATTENTION: Some Pelco-D / -P protocol domes and receivers require an address offset of -1. In other words, the address assigned to the dome / receiver in the DVR camera menu must be 1 below the address set in the dome / receiver itself! (i.e. DVR ID: 2, PTZ ID: 3)

2.4 Alarm Input / Output Installation

The EDR1640/1620/920 alarm inputs can be used for recording start or recording rate adjustment. Furthermore, alarm reactions such as camera switching to monitors, buzzer, e-mail and network alarm are available. An alarm output relay can be switched if required.

EDR920 provides 9 alarm inputs, EDR1640/1620 provides 16. All inputs are programmable NO/NC.

Inputs have to be switched through dry contacts.

The 4 output relays provide a dry NO/NC contact.

All settings are programmed in the **ALARM** menu.

Use either the 37-pin Sub-D plug or the included adaptor board for connection.

Pin assignment adaptor board

HOST			
PIN#	NAME	PIN#	NAME
1	GND	21	GND
2	ALMIN 1	22	ALM_NC1
3	ALMIN 2	23	ALM_NO1
4	ALMIN 3	24	ALM_COM1
5	ALMIN 4	25	ALM_NC2
6	ALMIN 5	26	ALM_NO2
7	GND	27	ALM_COM2
8	ALMIN 6	28	GND
9	ALMIN 7	29	ALM_NC3
10	ALMIN 8	30	ALM_NO3
11	ALMIN 9	31	ALM_COM3
12	ALMIN 10	32	ALM_NC4
13	GND	33	ALM_NO4
14	ALMIN 11	34	ALM_COM4
15	ALMIN 12	35	GND
16	ALMIN 13	36	ALMRST
17	ALMIN 14	37	REC_IN
18	ALMIN 15	38	SPARE_IN
19	ALMIN 16	39	DISK_FULL
20	GND	40	SPARE_OUT

Pin assignment sub-d board

DVR			
PIN	NAM	PIN	NAM
1	GN	19	GN
2	ALM 1	20	ALMNC0
3	ALM 2	21	ALM-NO
4	ALM 3	22	ALMCOM0
5	ALM 4	23	ALMNC1
6	ALM 5	24	ALM-NO
7	ALM 6	25	ALMCOM1
8	ALM 7	26	ALMNC2
9	ALM 8	27	ALM-NO
10	ALM 9	28	ALMCOM2
11	ALM 10	29	ALMNC3
12	ALM 11	30	ALM-NO
13	ALM 12	31	ALMCOM3
14	ALM 13	32	ALMRSTO
15	ALM 14	33	REC
16	ALM 15	34	GIN1
17	ALM 16	35	DISKFULL
18	GN	36	GO

Descriptions:

ALMINxx: Alarm input xx (1~16)

GND: common ground for alarm inputs

ALM_COMx: output relay x , contact root

ALM_NOx: output relay x , NO contact

ALM_NCx: output relay x , NC contact

ALMRST: Alarm reset, control input for alarm reset, for dry NO contact towards GND

DISKFULL: OC output contact for signal HDD full, switches to GND

REC_IN: Control contact for recording start

SPARE_IN / OUT: System error output. TTL-level 5VDC indicates "System Okay" status. The contact will switch to open state, if one (ore more) of below listed events appears:

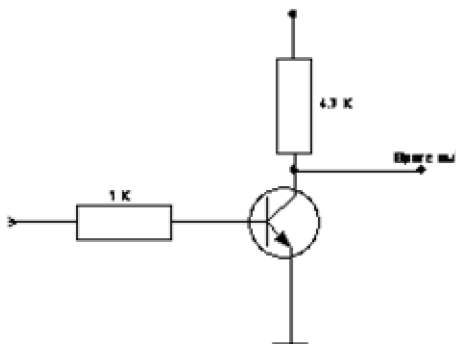

- a) HDD full (If overwrite mode in RECORD menu is set to STOP)
- b) No HDD
- c) Over-temperature HDD
- d) Power Loss
- e) Cooler fan fault
- f) Video Loss
- g) Record off

Output level:

HIGH (5 V DC): System okay

Open state: System error

SPARE_IN: N.O. Control input for playback function, playback is active as long contact is closed.

NO contact alarm input connection:



NC contact alarm input connection:



Output relay in idle state:

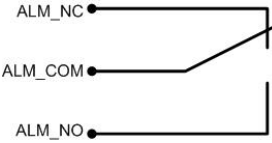

2.5 EDA800s Installation (optional)

The EDR1640/1620/920 image storage capacity can be expanded using EDA800s hard disk expansion units. Max. 6 EDA800s with 8 hard disks each can be connected via SCSI bus.

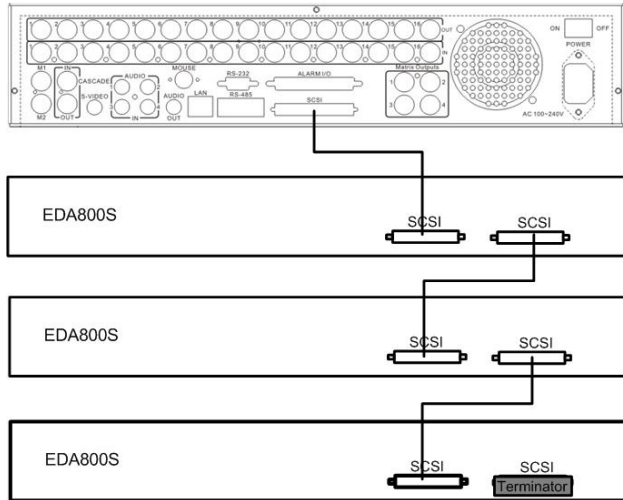

Diagram 2.8

For installation details of the EDA-800S hard disk expansion unit, please refer to the EDA800s manual.

2.6 Network Connection

EDR920/1620/1640 DVRs provide fast MPEG-4 format image transmission and network remote configuration.

This chapter doesn't go into basic networking. For further information, about router installation and internet connection please refer to the Chapter 10 through chapter 13.

Physically, two basic types of connection are possible:

2.6.1. Direct PC connection through crossover network cable

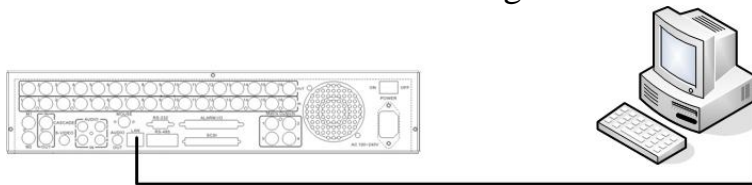

Diagram 2.9

The point-to-point connection of DVR and PC requires a crossover (crossed) network cable. This type of connection does not allow the connection of several PCs or DVRs.

Make sure that the PC is equipped with a 100 Mb compatible network connection.

2.6.2. Network connection through patch cable

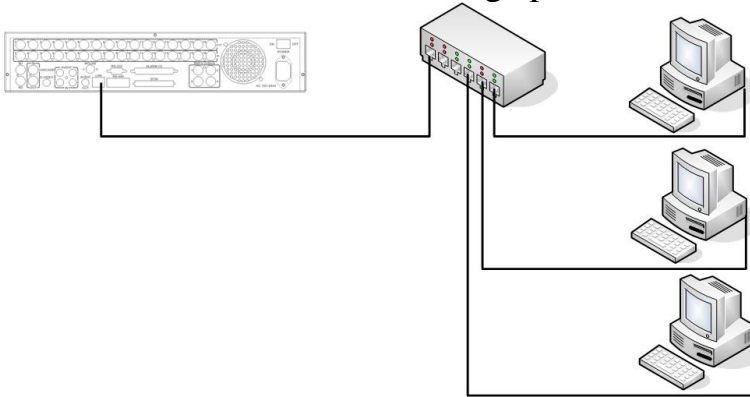

Diagram 2.10

The connection to an existing network requires a normal patch cable (straight-through). The illustration shows the connection to a network switch, router or modem.

2.6.3. Network system requirements

Connection type: 100Base-T

Max. required network bandwidth: 10 Mb

Protocol types: TCP, UDP, SMTP, HTTP, NTP

Required ports: for port configuration, please refer to **NETWORK** menu

2.7 Hard Disk Drive Installation

The first step in installing the hard drive is to insert the hard drive sleeve into the machine. The second step is to insert the key provided and turn it to the lock position. If this process is ignored the hard disk drive will not be detected. Follow the previous steps for the second hard drive or second empty sleeve. Both hard drives should be set to MASTER. Otherwise, they will not be detected.

- **Note:** A HDD should be installed before EDR1640/1620/920 is booted, or the EDR1640/1620/920 will not detect a HDD until you reboot it with a HDD. Please make sure the green HDD indicator light is ON. If the Hard Disk Drive is not locked in with the key the Hard Drive will not be recognized and the DVR will not go into record mode.
- **Note:** After powering on the DVR, it will start to load system. It takes a while to complete loading system; during this time, please do not install or remove the hard disk. No action is recommended while the machine is loading system.

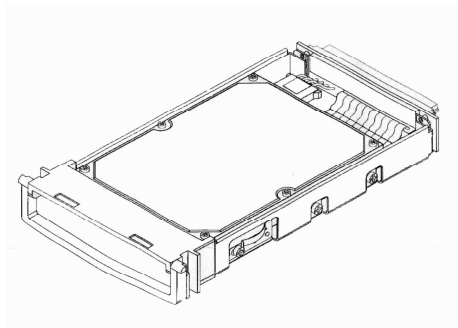

Diagram 2.11 shows 3.5" Hard Drive

2.8 Final Install Process

Once you have completed the basic wiring installation and the hard disk drive installation you are ready to turn on the DVR. Simply plug in the power source and turn the switch to the on position. The POWER LED lights will light up if power is normal. Once the system has finished loading, the next step is to set up the menu options for the DVR.

3. DVR Menu Setup

Assuming you have completed the first two chapters of this manual, you are now ready to begin setting up the digital video recorder. The following chapter will walk you through the detailed DVR Menu step by step and how to set the DVR for your specific application. To begin this process, press the **MENU** key. Once inside the main menu you will find there are 12 setup option pages as follows.

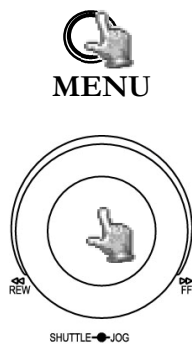

Press **MENU** key to enter the **MAIN MENU**.

Press **MENU** key or click on the arrow at the top right corner of the screen with a mouse to go back to the previous menu.

Dial the **Jog** clockwise or counterclockwise to change subentry values.

Press the **ENTER** key to go to next subentry in a menu setting, and press the **CALL** key to go to previous subentry in a menu setting. Or, simply use the left mouse click to go to a subentry in a menu setting and use scroll wheel of the mouse to change the value.



Diagram 3.1

3.1 Time/Date Setup Menu

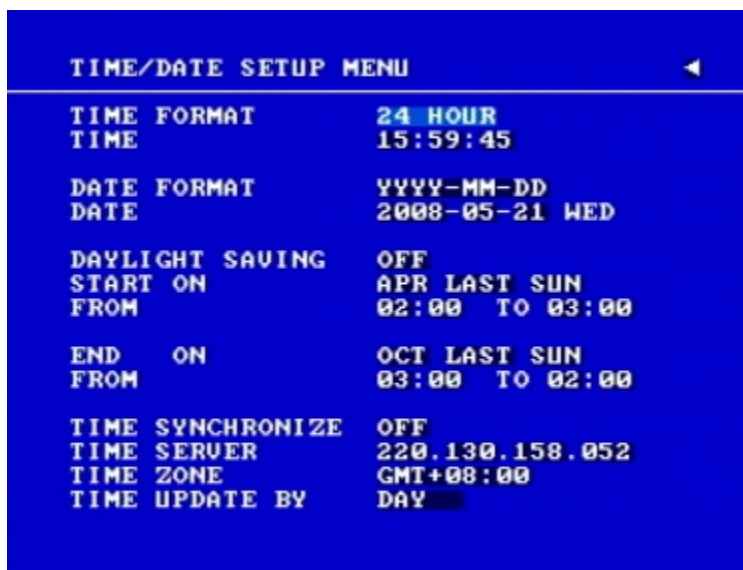

Diagram 3.2

Diagram 3.2 is a screen shot of the **TIME/DATE SETUP MENU**. This menu is used to set up the correct time and date for your region of the world. You are able to setup daylight savings as well as synch it with an internet based time server. In the **TIME/DATE SETUP MENU** the following fields are defined as follows:

1. **TIME FORMAT:** This field represents the time format on the DVR. You can select between **12 HOUR** and **24 HOUR** format.
2. **TIME:** This field represents the current time on the DVR. To change this, simply use the Jog Dial on the DVR.

The Time is represented as follows:

Hour: 00~23 (1~12 if TIME FORMAT is 12 HOUR); Minute: 00~59; Second: 00~59

3. **DATE FORMAT:** This field represents the date format on the DVR. To change this, simply use the Jog Dial on the DVR. There are three date formats which are **YYYY-MM-DD**, **MM-DD-YYYY** and **DD-MM-YYYY** to be selected.
4. **DATE:** This field represents the date on the DVR. To change this, simply use the Jog Dial on the DVR.

The date is represented as follows:

Year: 2000~2099 / Month: 01~12 / Date: 01~31 / Day of Week (automatically changes)

5. **DAYLIGHT SAVING:** This field represents the daylight savings on the DVR. To change this, simply use the Jog Dial on the DVR. Select “ON” or “OFF” to enable or disable daylight saving time function. In order to set a daylight saving time zone, you need to disable daylight saving first. Enable the daylight saving after finish setting the time zone.

6. **START TIME**

To set the start time of daylight saving time.

To set the start month of daylight saving time: Dial the jog to set the start month.



To set the start week of daylight saving time: Dial the jog to set the start week.



To set the start day of daylight saving time: Dial the jog to set the start day.



To set the starting time change of daylight saving time: Choose when the time changes from the old time (**FROM**) to the new time (**TO**) when daylight saving starts.

7. **END TIME:** To set the end time of daylight saving.

To set the end month of daylight saving time: Dial the jog to set the end month.



To set the end week of daylight saving time: Dial the jog to set the end week.



To set the end date of daylight saving time: Dial the jog to set the end date.



To set the ending time change of daylight saving time: Choose when the time changes from the old time (**FROM**) to the new time (**TO**) when daylight saving ends.

8. TIME SYNCHRONIZE

Select “**ON**” or “**OFF**” to enable or disable time synchronize, which will update the correct time automatically when network is connected. To change this, simply use the Jog Dial on the DVR.

9. TIME SERVER

You can set the time server address that the DVR connects to for time synchronize. To find the IP address of NTP Server, please follow these steps:

- a) Go to a PC that is connected to the internet.
- b) Click on “**START**” -> “**RUN**” -> type “**cmd**” -> press “**OK**”.
- c) In the Dos Prompt, type “**ping pool.ntp.org**” to find out the IP address of an NTP Server.

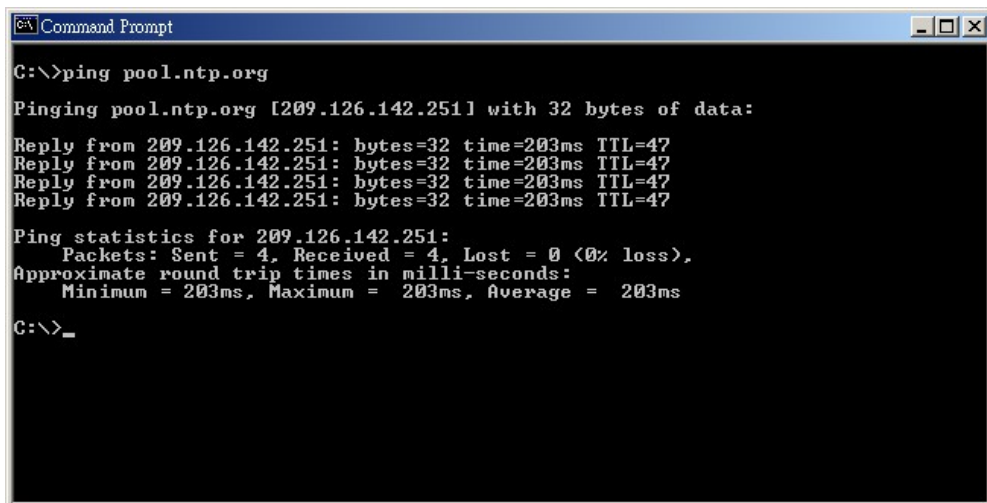

```
Command Prompt
C:\>ping pool.ntp.org
Pinging pool.ntp.org [209.126.142.251] with 32 bytes of data:
Reply from 209.126.142.251: bytes=32 time=203ms TTL=47
Reply from 209.126.142.251: bytes=32 time=203ms TTL=47
Reply from 209.126.142.251: bytes=32 time=203ms TTL=47
Reply from 209.126.142.251: bytes=32 time=203ms TTL=47
Ping statistics for 209.126.142.251:
    Packets: Sent = 4, Received = 4, Lost = 0 (0% loss),
    Approximate round trip times in milli-seconds:
        Minimum = 203ms, Maximum = 203ms, Average = 203ms
C:\>_
```

Diagram 3.3

10. TIME ZONE

You can set the time zone that the DVR adjusts to when updating from the time server.

Atlantic Daylight Time subtract 3 hours from GMT
Atlantic Standard Time subtract 4 hours from GMT
Eastern Daylight Time subtract 4 hours from GMT
Eastern Standard Time subtract 5 hours from GMT
Central Daylight Time subtract 5 hours from GMT
Central Standard Time subtract 6 hours from GMT
Mountain Daylight Time subtract 6 hours from GMT
Mountain Standard Time subtract 7 hours from GMT

Pacific Daylight Time subtract 7 hours from GMT
Pacific Standard Time subtract 8 hours from GMT
Alaska Daylight Time subtract 8 hours from GMT
Alaska Standard Time subtract 9 hours from GMT
Hawaii-Aleutian Daylight Time subtract 9 hours from GMT
Hawaii-Aleutian Standard Time subtract 10 hours from GMT

11. **TIME UPDATE BY**

Once you enable the **TIME SYNCHRONIZE**, you can select the synchronization frequency by:

DAY

WEEK

MONTH

3.2 Camera Setup Menu

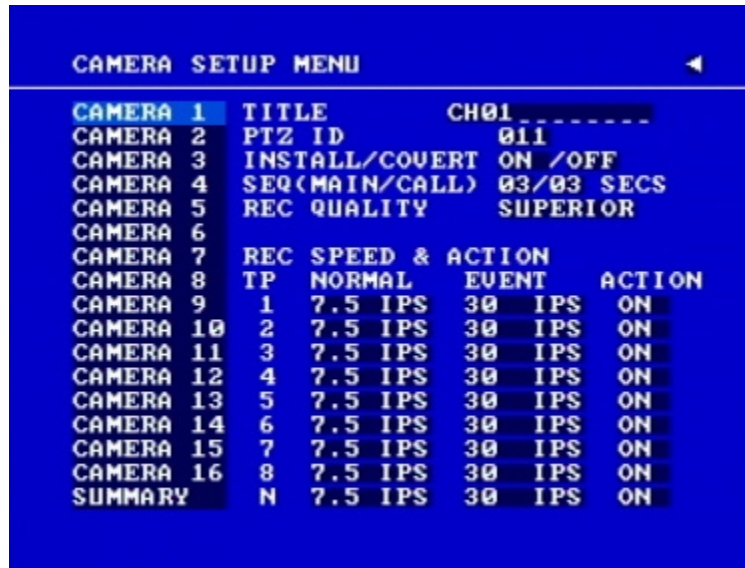

CAMERA SETUP MENU					
CAMERA 1	TITLE	CH01			
CAMERA 2	PTZ ID	011			
CAMERA 3	INSTALL/COVERT	ON /OFF			
CAMERA 4	SEQ(MAIN/CALL)	03/03 SECS			
CAMERA 5	REC QUALITY	SUPERIOR			
CAMERA 6					
CAMERA 7	REC SPEED &	ACTION			
CAMERA 8	TP	NORMAL	EVENT	ACTION	
CAMERA 9	1	7.5 IPS	30 IPS	ON	
CAMERA 10	2	7.5 IPS	30 IPS	ON	
CAMERA 11	3	7.5 IPS	30 IPS	ON	
CAMERA 12	4	7.5 IPS	30 IPS	ON	
CAMERA 13	5	7.5 IPS	30 IPS	ON	
CAMERA 14	6	7.5 IPS	30 IPS	ON	
CAMERA 15	7	7.5 IPS	30 IPS	ON	
CAMERA 16	8	7.5 IPS	30 IPS	ON	
SUMMARY	N	7.5 IPS	30 IPS	ON	

Diagram 3.4

Diagram 3.4 is a screen shot of the **CAMERA SETUP MENU**. This menu will walk you through setting up the Camera Recording Speeds, Camera titles, covert modes, and recording quality. In the **CAMERA SETUP MENU** the following fields are defined as:

1. **TITLE:** The title setting allows you to assign a title to each camera input. Each channel supports a title with up to 12 characters. Press Enter to move to each character and use the Jog Dial to change the value. The available alphanumeric characters are:

0,1,2,3,4,5,6,7,8,9,
A,B,C,D,E,F,G,H,I,J,K,L,M,N,O,P,Q,R,S,T,U,V,W,X,Y,Z,
() , + - / and an empty space.

2. **PTZ ID:** Select PTZ ID/Address from 001~255 or OFF. OFF is the same as 000. This ID must match the ID used by the PTZ camera. To change this, simply use the Jog Dial on the DVR.
3. **INSTALL/COVERT:** For installation of camera, select “ON” to enable a camera, and “OFF” to disable it. Please make sure to stop recording before making change to **INSTALL**. For optimum recording performance, switch any unused camera channels to OFF in this section. For covert, select “ON” to cover a camera and disable the screen in live mode. However, the image is recorded, and can be viewed in playback mode. Covert channels will not show up on the sequence mode. To change these, simply use the Jog Dial on the DVR.

4. **SEQ (MAIN/CALL):** Set the dwell time for sequences on the Main or Call Monitors. To change this, simply use the Jog Dial on the DVR.
5. **REC QUALITY:** Select an image quality for recording. There are six different qualities available. A higher image quality uses more HDD space. To change this, simply use the Jog Dial on the DVR. The estimated space needed per second lists below:

720x480		Video Source	
		Simple:	Complex:
Average size per image	LOWER:	8.04KB	12.33KB
	LOW:	8.42KB	13.7KB
	BASIC:	10.15KB	16.72KB
	STANDARD:	11.86KB	19.56KB
	HIGH:	14.72KB	24.63KB
	SUPERIOR:	18.60KB	30.05KB
720x240		Video Source	
		Simple:	Complex:
Average size per image	LOWER:	3.53KB	7.82KB
	LOW:	3.87KB	8.36KB
	BASIC:	4.21KB	8.9KB
	STANDARD:	4.92KB	9.54KB
	HIGH:	5.62KB	10.17KB
	SUPERIOR:	6.41KB	12.89KB
360x240		Video Source	
		Simple:	Complex:
Average size per image	LOWER:	1.76KB	4.56KB
	LOW:	1.87KB	4.87KB
	BASIC:	1.97KB	5.46KB
	STANDARD:	2.38KB	6.51KB
	HIGH:	2.67KB	7.08KB
	SUPERIOR:	3.63KB	9.02KB

Note: Since the compression ratio of MPEG4 depends on the variation and complexity of the recorded video, the table above is for your reference only.

6. REC SPEED & ACTION:

TP: Scheduled recording time 1~8 which can be set in the **SCHEDULE SETUP MENU**. “N” is the normal recording period, which is activated by pressing the Record button. If you have set a Time Period in Schedule Setup Menu, then there will be a star sign (*) beside that TP in Camera Setup Menu.

NORMAL: IPS recording rate for constant recording and recording triggered through “REC IN” input contact. The maximum image rate is limited to the maximum recording rate divided by the number of installed cameras.

EVENT: IPS recording rate for motion or alarm events. Event record speed can be set from 1 to 30 IPS (25 for PAL) or “OFF”.

Note: In order to activate a new record speed, you need to disable all current record actions and then turn them back on.

ACTION

Set “**ON**” to activate motion action on a Time Period.

Set “**OFF**” to disable motion action on a Time Period.

This setting correlates closely with Motion Setup. If motion setting is disabled, motion detection will not function regardless if Action in Camera Setup Menu is ON or OFF.

However, if Motion setting is **enabled**, then motion detection function works depending on **Action** setting in Camera Setup Menu. All motion actions (including buzzer, relay, network alarm, e-mail and log) will be triggered if they are enabled in Motion Setup Menu as long as Action is “**ON**” for the TP (Time Period) you have set. If you do not wish to have motion detected for a specific time, set Action “**OFF**” for that Time Period. This function gives you flexibility to set motion detection function ON or OFF for different Time Periods.

7. SUMMARY :



CAMERA	ITEM	TITLE
CAMERA 1	1	CH01
CAMERA 2	2	CH02
CAMERA 3	3	CH03
CAMERA 4	4	CH04
CAMERA 5	5	CH05
CAMERA 6	6	CH06
CAMERA 7	7	CH07
CAMERA 8	8	CH08
CAMERA 9	9	CH09
CAMERA 10	10	CH10
CAMERA 11	11	CH11
CAMERA 12	12	CH12
CAMERA 13	13	CH13
CAMERA 14	14	CH14
CAMERA 15	15	CH15
CAMERA 16	16	CH16
SUMMARY		

Diagram 3.5

Dial **Jog** to change items in the **SUMMARY** table.

All cameras' statuses are shown in the **SUMMARY** table. The table is for checking camera overall statuses only, not for setting.

Note: The SUMMARY table also exists in ALARM, MOTION and VIDEOLOSS SETUP MENU. All of these SUMMARY tables are also for checking particular overall statuses, not for setting.

- Copy camera's setting from a camera to other cameras:** In order to quickly copy the setting from one camera to other cameras, we provide a copy function for camera settings. Highlight the desired camera from the list on the left, and then press **COPY**. COPIED will show up in the top right corner of the screen. Dial the **Jog** to the camera you would like to copy to, and then press **SEARCH** to paste. The previous settings of the camera will be overwritten, and PASTED will be displayed in the top right corner.

Note: TITLE, PTZ ID, and INSTALL/COVERT cannot be copied. These 3 options must be set independently.

3.3 Record Setup Menu



Diagram 3.6

Diagram 3.6 is a screen shot of the **RECORD SETUP MENU**. This menu is for setting up the options for recording audio and video. In the **RECORD SETUP MENU** the following fields are defined as follows:

1. **RECORD AUDIO:**

YES: Audio will be recorded when machine is recording and a microphone is present.

NO: Audio will not be recorded when machine is recording.

2. **TIME STAMP:**

ON: The time stamp will show on the video and picture when recording.

OFF: The time stamp will not show on the video and picture when recording.

3. **TIME STAMP POSITION:**

BOTTOM: The time stamp will show on the bottom.

TOP: The time stamp will show on the top.

4. **WATER MARK:**

ON: Recording is overlaid by a visible watermark (“W”).

OFF: No watermark.

5. **RESOLUTION:** The resolutions for NTSC are 720x480, 720x240 and 360x240. The default value is 720x240. The resolutions for PAL are 720x288, 720x576 and 360x288. The default value is 720x288.

Note: Selecting a certain resolution will determine the amount of IPS the DVR will support.

NTSC

720x480 = 120 IPS (EDR1640) or 60 IPS (EDR1620/920)

720x240 = 240 IPS (EDR1640) or 120 IPS (EDR1620/920)

360x240 = 480 IPS (EDR1640) or 240 IPS (EDR1620/920)

6. **RECORD MODE:**

REWRITE: Continue recording. Disk will begin overwriting when it is full.

STOP: Stop recording when disk is full.

7. **AUTOWRITE WITHIN:** You can set DVR to automatically overwrite after the selected number of days. If you do not wish to use this function, simply select “0”.

8. **PRE-ALARM RECORDING**

Select “YES” to enable pre-alarm recording function. Select “NO” to disable pre-alarm recording function.

9. **RELAY OUT**

By selecting “1”, user can easily identify whether DVR is recording or not if relay output is connected to a signaling device. Select “NONE” if you do not wish to identify recording status.

3.4 Alarm Setup Menu

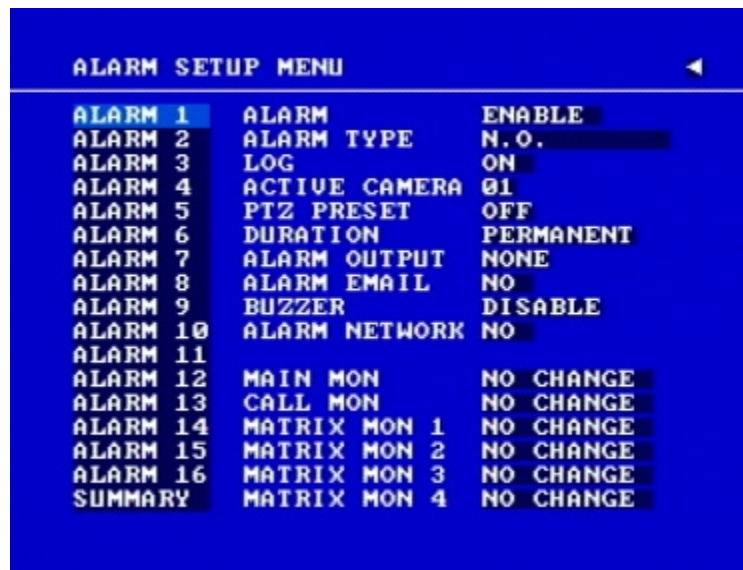

ALARM SETUP MENU		
ALARM 1	ALARM	ENABLE
ALARM 2	ALARM TYPE	N.O.
ALARM 3	LOG	ON
ALARM 4	ACTIVE CAMERA	01
ALARM 5	PTZ PRESET	OFF
ALARM 6	DURATION	PERMANENT
ALARM 7	ALARM OUTPUT	NONE
ALARM 8	ALARM EMAIL	NO
ALARM 9	BUZZER	DISABLE
ALARM 10	ALARM NETWORK	NO
ALARM 11		
ALARM 12	MAIN MON	NO CHANGE
ALARM 13	CALL MON	NO CHANGE
ALARM 14	MATRIX MON 1	NO CHANGE
ALARM 15	MATRIX MON 2	NO CHANGE
ALARM 16	MATRIX MON 3	NO CHANGE
SUMMARY	MATRIX MON 4	NO CHANGE

Diagram 3.7

Diagram 3.7 is a screen shot of the **ALARM SETUP MENU**. An alarm is defined as an electronic or mechanical device that sends a warning signal under specific circumstances. In this case the signal triggers the recorder to start recording the alarmed event. This menu contains all the alarm operations and options needed to successfully complete an alarm recording. In the **ALARM SETUP MENU** the following fields are defined:

1. ALARM

This field is to turn alarm detection on or off. The default value is **ENABLE**. To change this, simply use the Jog Dial on the DVR.

ENABLE: Enable alarm detection.

DISABLE: Disable alarm detection.

2. ALARM TYPE

This field is to change the type of alarm recording. The default value is **N.O.** To change this, simply use the Jog Dial on the DVR.

N. O.: Normal Open alarm.

N. C.: Normal Close alarm.

N.O. Trans.: When the alarm is triggered, buzzer, alarm output and alarm recording remain active until alarm is set back to **N.O.**

N.C. Trans.: When the alarm is triggered, buzzer, alarm output and alarm recording remain active until alarm is set back to **N.C.**

3. **LOG**
YES: Select **YES** if you wish to record Alarm Events in the Log.
NO: Select **NO** if you do not wish to record Alarm Events in the Log.
4. **ACTIVE CAMERA**
This field is to activate camera you want to have the alarm enabled too. For example if you had an external motion detector on camera one you would set this option to camera one. The Default setting is the same camera number as the current alarm. To change this, simply use the Jog Dial on the DVR.
5. **PTZ PRESET**
Select **PTZ PRESET** from “001” to “255”, so that when Alarm occurs, speed dome will turn to a preset position for event recording. This function improves surveillance quality of an alarm event. If you wish to disable this function, simply select “OFF”.
6. **DURATION**
1~99 SEC: The amount of time alarm recording, screen change, buzzer and output contact will last. Adjustable from 1 ~ 99 seconds.
TRANSPARENT: Continuous recording, screen change, buzzer, and output contact for a triggered alarm event.
7. **ALARM OUTPUT**
This will transmit a signal to another device. The setting of alarms are **NONE = not activated, 1 = output signal 1 transmits, 2 = output signal 2 transmits, 3 = output signal 3 transmits and 4 = output signal 4 transmits.**
8. **ALARM EMAIL**
Select “**YES**” to send an email when alarm occurs or “**NO**” to disable alarm email. The email address can be set in the **NETWORK SETUP MENU**.
9. **BUZZER:** Audible alarm buzzer.

ENABLE: To enable the alarm buzzer.
DISABLE: To disable the alarm buzzer.
10. **ALARM NETWORK**

YES: Enable alarm network.
NO: Disable alarm network.
11. **MAIN MON:** Display on main monitor when an alarm occurs.
NO CHANGE: No change on the main monitor display when an alarm occurs.
FULLSCREEN: A full screen of the active camera will display when an alarm occurs.

12. **CALL MON:** Display on a call monitor when an alarm occurs.
NO CHANGE: No change on the call monitor display when an alarm occurs.
SEQUENCE: Display in sequence mode on call monitor when an alarm occurs, according to sequence duration set in Camera Setup Menu.
ACTIVE CAMERA: Display the active camera in full screen mode to the call monitor when an alarm occurs.

13. **SUMMARY**
Dial **Jog** to change items in the **SUMMARY** table. All alarms' statuses are shown in **SUMMARY** tables. These tables are for checking overall alarm statuses, not for changing them.

3.5 Motion Setup Menu

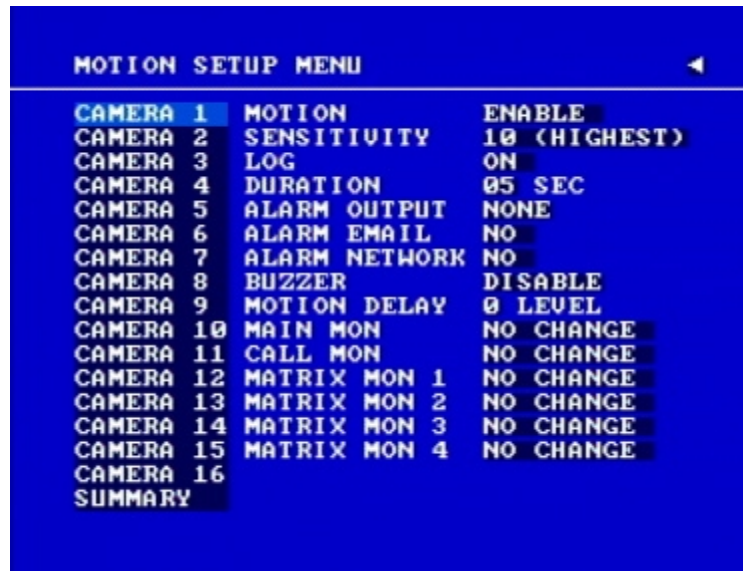

Diagram 3.8

Diagram 3.8 is a screen shot of the **MOTION SETUP MENU**. We define motion as a change of pixilation in the field of view, which is detected by the digital video recorder and triggers the recorder to start recording. This menu is for setting up the digital recorder for motion recording on a per camera basis.

In the **MOTION SETUP MENU** the following fields are defined as follows:

1. **MOTION**

This field is to turn motion detection on or off. The default value is **DISABLE**. To change this, simply use the Jog Dial on the DVR.

ENABLE: Enable motion detection.

DISABLE: Disable motion detection.

Note: Motion only works in live and playback modes. It is invalid while in menus.

2. **SENSITIVITY**

The sensitivity allows users to adjust to a suitable motion detection sensitivity. There are 10 sensitivities available; level 1 is the lowest, and level 10 is the highest. To change this, simply use the Jog Dial on the DVR.

3. **LOG**

YES: Select **YES** if you wish to record Motion Events in the Log.

NO: Select **NO** if you do not wish to record Motion Events in the Log.

4. **DURATION**

The amount of time a motion event will record - from 1 sec to 99 seconds. The default value is 5 seconds. To change this, simply use the Jog Dial on the DVR.

5. **ALARM OUTPUT**

This will transmit a signal to another device. The setting of alarms are **NONE = not activated, 1 = output signal 1 transmits, 2 = output signal 2 transmits, 3 = output signal 3 transmits and 4 = output signal 4 transmits.** To change this, simply use the Jog Dial on the DVR.

6. **ALARM EMAIL**

YES: Send an email when an alarm occurs.

NO: Do not send an email when an alarm occurs.

The email address and email server can be set in the **NETWORK SETUP MENU.**

7. **ALARM NETWORK**

YES: Enable alarm network when an alarm occurs.

NO: Disable alarm network when an alarm occurs.

8. **BUZZER:** Audible buzzer when motion is detected.

ENABLE: To enable a motion buzzer.

DISABLE: To disable a motion buzzer.

9. **MOTION DELAY:**

Select motion delay time from 0~7 level.

10. **MAIN MON:** Display on main monitor when motion occurs.

NO CHANGE: No change on the main monitor display when a motion occurs.

FULLSCREEN: A full screen of the active camera will display when motion occurs.

11. **CALL MON:** Display on a call monitor when motion occurs.

NO CHANGE: No change on the call monitor display when motion occurs.

ACTIVE CAMERA: Display the active camera that is set for **Motion** in full screen mode to the call monitor.

12. **SUMMARY**

Dial **Jog** to change items in the **SUMMARY** table. All alarm's statuses are shown in **SUMMARY** tables. These tables are for checking alarm overall statuses, not for changing them.

13. MOTION AREA

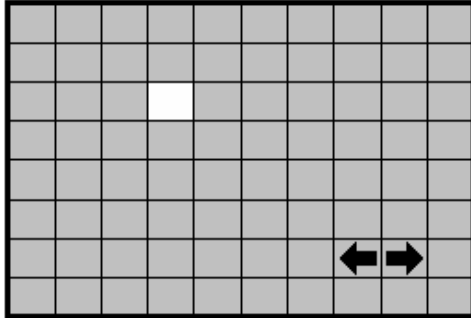

Enter a desired channel and press **SELECT** or middle mouse button to edit a motion area. MOTION must be set as “**Enable**” in order to edit the motion detection area.



In the motion edit mode:

The default motion area of each camera is entire screen which displays in light green.

Press **COPY** or left-click the mouse to start setting an area.

Use the **JOG** Dial to move the cursor. Press **ENTER** to switch between vertical  and horizontal  movement.

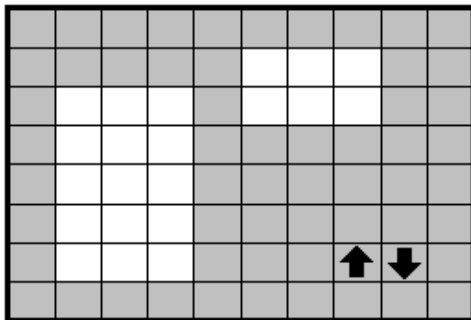

Press **SEARCH** to end and enable the area, or press **PAUSE** to end and disable the area.

Alternatively, right-click the mouse to obtain a selection menu, then use the “+” or “-” signs to either select “ON” to enable the area or “OFF” to disable the area, then click “OK”.

To quit the motion area edit, press **MENU** or right-click the mouse to obtain a selection menu, select “EXIT” by clicking the “+” or “-” sign. Then press “OK”.

- **To test a motion area:** Grids will turn from green to red when motion is detected.
- **To clear the motion entire area:** Press **PLAY** to clear the entire motion area.
- **If you forget the motion grid commands:** Press **CALL** to display a hint window (shown below).

MENU	- EXIT
COPY	- SELECT AREA
ENTER	- CHANGE DIR
SEARCH	- ON AREA
PAUSE	- OFF AREA

3.6 VIDEOLOSS Setup Menu

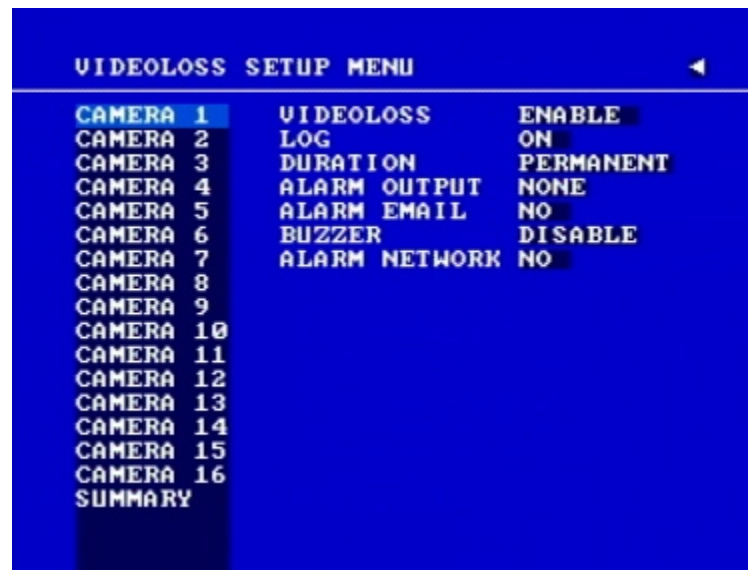

Diagram 3.9

Diagram 3.9 is a screen shot of the **VIDEOLOSS (Video Loss) SETUP MENU**. VIDEOLOSS event is caused by no video signal input for the channel, usually when the camera fails or loses power. How to set up system response for VIDEOLOSS is introduced in this section.

In the **VIDEOLOSS SETUP MENU** the following fields are defined as follows:

1. **VIDEOLOSS:**

ENABLE: Enable video loss detection.

DISABLE: Disable video loss detection.

2. **LOG:**

YES: Select **YES** if you wish to record Video Loss Events in the Log.

NO: Select **NO** if you do not wish to record Video Loss Events in the Log.

3. **DURATION:**

Duration of VIDEOLOSS buzzer ranges from 1 sec to 99 seconds. The default value is 5 seconds. To change this, simply use the Jog Dial on the DVR.

4. **ALARM OUTPUT:**

This will transmit a signal to another device. The setting of alarms are **NONE = not activated, 1 = output signal 1 transmits, 2 = output signal 2 transmits, 3 = output signal 3 transmits and 4 = output signal 4 transmits**. To change this, simply use the Jog Dial on the DVR.

5. **ALARM EMAIL:**
Select “**YES**” for sending an email when Video Loss event occurs. The email address can be set in the **NETWORK SETUP MENU**.

6. **BUZZER:** Audible alarm buzzer.

ENABLE: To enable a VIDEOLOSS buzzer.
DISABLE: To disable a VIDEOLOSS buzzer.

7. **ALARM NETWORK:**

YES: Enable alarm network.
NO: Disable alarm network.

8. **SUMMARY**
All video loss’s statuses are shown in **SUMMARY** tables. These tables are for checking video loss overall statuses, but not for changing them.

3.7 Network Setup Menu



Diagram 3.10

Diagram 3.10 is a screen shot of the **NETWORK SETUP MENU**. This menu is for setting up the configurations for networking to the DVR. There are 6 subentries in the **NETWORK SETUP MENU**: **CONFIG**, **ALARM**, **EMAIL**, **PASSWORD**, **PPPoE** and **DDNS**. Please refer to the Networking Chapter of this manual to fully understand how to setup your network for this DVR. In the Network Setting Menu the following fields are defined as follows:

***Note:** Since every Network Configuration is different, please contact your Network Administrator or ISP for how to assign those IP addresses and port numbers.*

3.7.1 CONFIG

In the **CONFIG** of the **NETWORK SETUP MENU**, we define:

1. **IP CONFIG:**

FIXED IP: User can set a fixed IP for network connection.

DHCP: DHCP server in LAN will automatically provide the IP for network connection

PPPoE: This is a DSL connection application, ISP will ask user to input user name and password. Before choosing this option, please go to PPPoE configuration menu for setting PPPoE configuration.

2. **IP Address**

This field shows the current IP Address for the DVR. A Fixed IP address does not change and must be set manually. To change this, simply use the Jog Dial on the DVR. When DHCP is selected, the DHCP server will assign this value automatically.

Note: The addresses in the machine are for our own testing you must apply your own addresses to comply with your network. Refer to Networking Chapter for more details.

3. **SUBNET MASK**

This field is to set the subnet mask for your network so as the DVR will be recognized within the network. Example: 255.255.255.000. To change this, simply use the Jog Dial on the DVR. When DHCP is selected, the DHCP server will assign this value automatically.

4. **GATEWAY**

This field is to set the gateway for your network so the DVR will be recognized within the network. To change this, simply use the Jog Dial on the DVR. When DHCP is selected, the DHCP server will assign this value automatically.

5. **DNS SERVER**

This field is to set the DNS server for your network so the DVR will be recognized within the network. To change this, simply use the Jog Dial on the DVR. When DHCP is selected, the DHCP server will assign this value automatically.

6. **REMOTE RELAY CONTROL:**

YES: By selecting **YES**, system will accept remote command of relay control.

NO: By selecting **NO**, system will refuse remote command of relay control.

7. **HTTP PORT**

The default port number is 80. User can change it to different port number for HTTP/WEB communication between DVR and client PC.

8. **CONTROL PORT**

The default port number is 1600. User can change it to different port number for controlling authentication between DVR and client PC.

9. **DATA PORT**

The default data transmitting port number is 37260. User can change it to different port number for data transfer between DVR and client PC.

10. **BW CONTROL**

This configuration allows user to control the bandwidth of DVR.

11. **MAC ADDR**

This field is for those Internet service providers or Network administrators who require a MAC address of the network card of the DVR. This option cannot be changed.

3.7.2 ALARM (NETWORK)

DVR can send out Alarm message to an Alarm Server. This function is reserved to work with our Control Management System – PowerCon4. In the **ALARM** of the **NETWORK SETUP MENU**, we define:



Diagram 3.11

Note: Since every Network Configuration is different, please contact your Network Administrator or ISP for how to assign those IP addresses and port numbers.

1. **PROTOCOL:** Select which communication protocol with Alarm servers or Alarm receiving clients.

TCP: communicate with client via TCP protocol.

UDP: communicate with client via UDP protocol.

2. **PORT NUMBER:** setting the communication port with Alarm server.
3. **UNIQUE ID:** setting the ID number of your DVR to Alarm server.

4. **SERVER 1:** assign the IP address of Alarm server 1.
5. **SERVER 2:** assign the IP address of Alarm server 2.
6. **SERVER 3:** assign the IP address of Alarm server 3.

3.7.3 EMAIL

In the **EMAIL** of the **NETWORK SETUP MENU**, we define:



Diagram 3.12

In the **EMAIL** of the **NETWORK SETUP MENU**, we define:

1. **SMTP SERVER**
Assign the SMTP (e-mail) server's name.
Note: For more reliable email service, use the server's IP address.
2. **PORT NUMBER**
Assign the port number for SMTP server. The default port is 25.
3. **AUTHENTICATION**
Select "YES", if the SMTP server requires Authentication (user name / password)
4. **USER**
Input the login user ID if the SMTP server requires Authentication.

5. **PASSWD**

Input the password if the SMTP server requires Authentication.

6. **RECEIV. EMAIL ADDR**

Input the e-mail address for receiving e-mail messages when the EVENT is enabled and triggered. Example: In Motion Setup Menu, if the “EMAIL/NETWORK” is set to “YES”, this e-mail address will receive a message and a still image (in “ARV” format) from the DVR when Motion is triggered. This “ARV” file can be played back by opening “DVRViewer.exe” which can be downloaded from the DVR’s Network Viewer or from the Copy Menu.

7. **SENDER EMAIL ADDR**

Input sender’s e-mail address, so that receiver can recognize the sender when an event message is sent out.

3.7.4 PASSWORD

In the **PASSWORD** of the **NETWORK SETUP MENU**, we define:



The screenshot shows a terminal window with a blue background and white text. The title is "NETWORK SETUP MENU". On the left side, there is a vertical menu with options: CONFIG, ALARM, EMAIL, PASSWORD (highlighted), PPPoE, and DDNS. The main area displays a table with four columns: NAME, PASSWORD, and LEVEL. The table lists six users: ADMIN, USER2, USER3, USER4, USER5, and USER6. Each user has a password field filled with asterisks and a level (ADMIN or LIVE).

NAME	PASSWORD	LEVEL
1 ADMIN	*****	ADMIN
2 USER2	*****	LIVE
3 USER3	*****	LIVE
4 USER4	*****	LIVE
5 USER5	*****	LIVE
6 USER6	*****	LIVE

Diagram 3.13

In the **PASSWORD** of the **NETWORK SETUP MENU**, we define:

Name/Password/Level: This category is to set up the users that will log into the network. Please remember that this portion of the Network setting menu is set up in column format.

The default User Name = ADMIN

The default Password = 1111111

To change this, press Enter to move to each character and use the Jog Dial on the DVR to change each character. Note that the password is limited to numbers only.

There are 3 level types:

1. **Admin:** User has all the rights including viewing live video, performing a search, playback and controlling the PTZ camera (if one is connected).
2. **Play:** User has the same rights as Admin user. Except PTZ programming and Remote configuration are not authorized to **Play** level users.
3. **Live:** Allows user only to view live video.

3.7.5 PPPOE

In the **PPPOE** of the **NETWORK SETUP MENU**, we define:



Diagram 3.14

In the **PPPoE** of the **NETWORK SETUP MENU**, we define:

1. **USER**
User name that is provided by ISP for PPPoE Connection
2. **PASSWD**
Password that is provided by ISP for PPPoE connection
3. **PRIMARY DNS**
IP address of DNS server that is provided by ISP.

4. SECONDARY DNS

If your ISP provides you with a secondary DNS address, please set it in here.

NOTE:

*Please complete all settings in the **PPPoE** Setup Menu before changing IP CONFIG to PPPoE in the **CONFIG** options. If you make this change before completing **PPPoE** settings, then the PPPoE function will not work.*

3.7.6 DDNS

In the **DDNS** of the **NETWORK SETUP MENU**, we define:



Diagram 3.15

In **DDNS** of the **NETWORK SETUP MENU**, we define :

1. **SERVER**
DDNS provider (example: www.dyndns.com)
2. **USER**
User name of the account.
3. **PASSWD**
Password of the account.

4. **RECORD ID**
Identity tag used by certain DDNS providers
5. **FQDN**
The domain name of this account.

***NOTE:** If using “EverFocusDDNS.com” as the server, there is less information required. For more details on DDNS setup, see the Networking section of the manual.*

3.8 Schedule Setup Menu

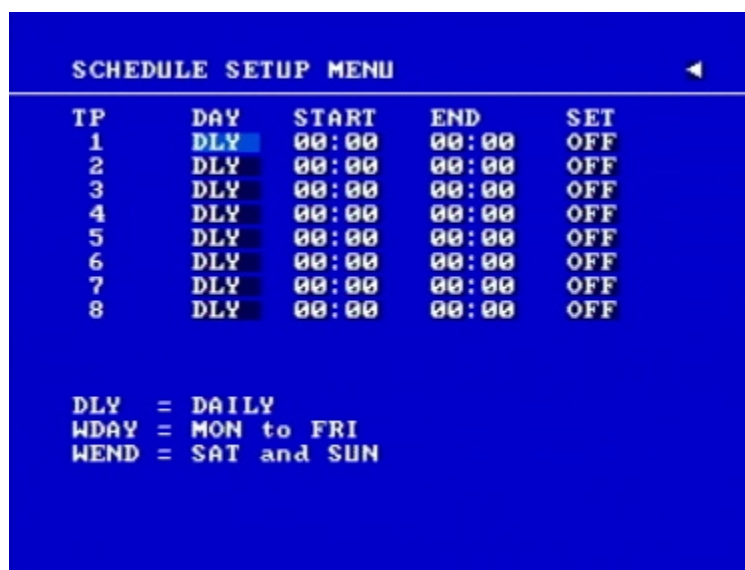

TP	DAY	START	END	SET
1	DLY	00:00	00:00	OFF
2	DLY	00:00	00:00	OFF
3	DLY	00:00	00:00	OFF
4	DLY	00:00	00:00	OFF
5	DLY	00:00	00:00	OFF
6	DLY	00:00	00:00	OFF
7	DLY	00:00	00:00	OFF
8	DLY	00:00	00:00	OFF

DLY = DAILY
WDAY = MON to FRI
WEND = SAT and SUN

Diagram 3.16

Diagram 3.16 is a screen shot of the **SCHEDULE SETUP MENU**. In this menu you can set a unique timer to start recording from a specified start time to an end time. This menu works together with the CAMERA menu; you will notice TP (time period) 1~8, which is also seen in the CAMERA menu.

In the **SCHEDULE SETUP MENU** the following fields are defined as:

1. DAY

This field represents the day of the week you wish to set the timer record for. Initially it is set to DLY as default. You may choose from MON-SUN as well as WDAY, WEND, and DLY. To change this, simply use the Jog Dial on the DVR.

MON (Monday), **TUE** (Tuesday), **WED** (Wednesday), **THU** (Thursday), **FRI** (Friday), **SAT** (Saturday), **SUN** (Sunday).

WDAY: Weekday, from Monday to Friday.

WEND: Weekend, Saturday and Sunday.

DLY: Daily, every day of the week.

2. START

This field is used to set the time you wish to start the timer recording. To change this, simply use the Jog Dial on the DVR.

Hour: 0 ~ 23 in 24 hour time format; **1~12** in 12 hour time format.
Minutes: 00 ~ 59

3. **END**

This field is used to set the time you wish to stop the timer recording. To change this, simply use the Jog Dial on the DVR.

Hour: 0 ~ 23 in 24 hour time format; **1~12** in 12 hour time format.
Minutes: 00 ~ 59

Note: To record a 24-hour period: set 12:00am~12:00 am for 12-hour format; 00:00~00:00 for 24-hour format.

4. **SET**

This field is used to turn the timer recording on or off. To change this, simply use the Jog Dial on the DVR.

ON: Enable a scheduled record time period.

OFF: Disable a scheduled record time period.

3.9 Disk Setup Menu

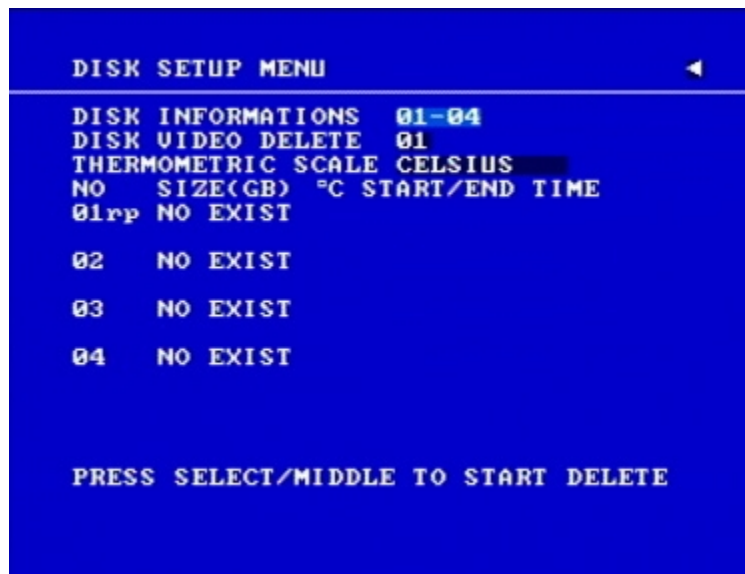

Diagram 3.17

Diagram 3.17 is a screen shot of the **DISK SETUP MENU**. This menu is for viewing Disk information and formatting the disks. For initial setup or major setup changes we recommend formatting the Hard Disk.

In the **DISK SETUP MENU** the following fields are defined as follows:

1. **DISK INFORMATION**

Select disk information, it is selectable from 1 up to 50 disks, in intervals of 4. The total number of hard drives varies by model.

2. **DISK VIDEO DELETE**

Press **SELECT** to start delete. A delete disk confirmation window will show up after pressing **SELECT** button.

Dial the Jog to move highlighter to **YES**, and then press **SELECT** button; a deleting indicator **DELETE.....** will show up. An indicator of success **SUCCESS.....** will show up when delete is completed.

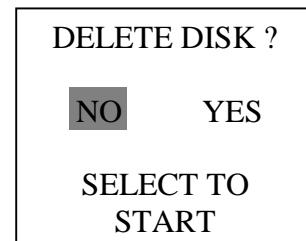

If you do not want to delete the disk after the delete disk confirmation window shows up, you can move highlighter to **NO**, and then press **SELECT** to quit.

Note: System will ask you to stop recording if you try to delete the disk while still in the record mode.

3. **THERMOMETRIC SCALE**

Select **CELSIUS** or **FAHRENHEIT** for thermometric scale of the disk.

4. **NO**

Shows the hard drive number. The number of disks displayed may vary depending on the model.

5. **SIZE**

Storage capacity of the hard drive.

6. **°C (or °F)**

Current temperature of the hard drive in Celsius or Fahrenheit degrees.

7. **START/END TIME**

Shows the date and time range stored on the hard drives.

3.10 Control Setup Menu



Diagram 3.18

Diagram 3.18 is a screen shot of the Control Setting Menu. This menu is to define the settings for DVR remote control through serial interface in the RS232/RS485 menu. The following fields are defined in the **Control Setting Menu**:

RS232:

1. **RS232 Baud Rate**

This field is to set the speed at which is used to transmit instruction or information through the RS232 port on the DVR. There are six different speeds, 2400 BPS, 4800 BPS, 9600 BPS, 19200 BPS, 38400 BPS and 57600 BPS. The default setting from the factory is 9600 BPS. To change this, simply use the Jog Dial on the DVR.

2. **RS232 Stop Bit**

This field is to set the stop bit for the RS232 connection. There are two different stop bits, 1 or 2. The default in the DVR is set to 1. To change this, simply use the Jog Dial on the DVR.

3. **RS232 Parity**

This field is to select the parity level at which you will be connected. You can choose between None, Odd, or Even parity levels. Default is set to none. To change this, simply use the Jog Dial on the DVR.

4. **RS232 Data Bit**

This field is the data bit at which you will be transferring. There are two settings for this option: 8 or 7. The default is set to 8. To change this, simply use the Jog Dial on the DVR.

RS485:

1. **RS485 Baud Rate**

This field is to set the speed at which is used to transmit instruction or information through the RS485 port on the DVR. There are six different speeds, **2400, 4800, 9600, 19200, 38400** and **57600** BPS. The default setting from the factory is 9600 BPS. To change this, simply use the Jog Dial on the DVR.

2. **RS485 Stop Bit**

This field is to set the stop bit for the RS485 connection. There are two different stop bits, 1 or 2. The default in the DVR is set to 1. To change this, simply use the Jog Dial on the DVR.

3. **RS485 Parity**

This field is to select the parity level at which you will be connected. You can choose between None, Odd, or Even parity levels. Default is set to none. To change this, simply use the Jog Dial on the DVR.

4. **RS485 Data Bit**

This field is the data bit at which you will be transferring. There are two settings for this option: 8 or 7. The default is set to 8. To change this, simply use the Jog Dial on the DVR.

RS232/RS485 ID

This entry is used to assign each device its own ID code if more than one DVR is used through the RS232/RS485 connection. The default is set to 001. To change this, simply use the Jog Dial on the DVR.

PTZ PROTOCOL

Select PTZ protocol from **EVERFOCUS, PELCO-D, PELCO-P, ED2200/2250** and **ELMO**.

3.11 Warning Setup Menu



Diagram 3.19

Diagram 3.19 is a screen shot of the **Warning Setup Menu**. This menu is to set the warning system settings. If any critical errors occur, this portion of the menu directs how the system reacts. In the **Warning Setup Menu**, the following fields are defined:

3.11.1 FAN FAULT

In **FAN FAULT**, we define:

1. **BUZZER:** Fan buzzer. To change this, simply use the Jog Dial on the DVR.
ENABLE: To enable a buzzer when the fan does not work.
DISABLE: To disable fan buzzer.
2. **ALARM OUTPUT**
This will transmit a signal to another device. The setting of alarms are **NONE = not activated, 1 = output signal 1 transmits, 2 = output signal 2 transmits, 3 = output signal 3 transmits and 4 = output signal 4 transmits**. To change this, simply use the Jog Dial on the DVR.
3. **ALARM DURATION**
Permanent. This setting cannot be changed.
4. **NETWORK ALARM**
YES: To enable network alarm.
NO: To disable network alarm.

5. **SEND EMAIL:**

YES: Send an email when the fan does not work.

NO: Do not send an email when the fan does not work.

The email settings can be set in the **NETWORK SETUP MENU**.

3.11.2 HDD TEMP

In **HDD TEMP**, we define:



Diagram 3.20

In **HDD TEMP**, we define:

1. **BUZZER:** HDD TEMPERATURE buzzer.

ENABLE: To enable a buzzer when HDD's temperature is higher than the temperature set in "SET TEMPERATURE".

DISABLE: To disable HDD TEMP Buzzer.

2. **ALARM OUTPUT**

This will transmit a signal to another device. The setting of alarms are **NONE = not activated, 1 = output signal 1 transmits, 2 = output signal 2 transmits, 3 = output signal 3 transmits and 4 = output signal 4 transmits.** To change this, simply use the Jog Dial on the DVR.

3. **ALARM DURATION**

Permanent. This setting cannot be changed.

4. **NETWORK ALARM**

YES: To enable network alarm.

NO: To disable network alarm.

5. **SEND EMAIL**

YES: Send an email when HDD's temperature is overheated.

NO: Will not send an email when HDD's temperature is overheated.

The email settings can be set in the **NETWORK SETUP MENU**.

6. **STOP RECORD**

YES: Stop recording when HDD's temperature is overheated.

NO: Will not stop recording even when HDD's temperature is overheated.

7. **SET TEMPERATURE:**

When HDD's temperature is higher than the temperature set here, all other active settings in HDD TEMP will take effect (BUZZER, ALARM OUTPUT, ALARM DURATION, NETWORK ALARM, SEND EMAIL, STOP RECORD). The default value is 60°C (140°F).

3.11.3 NO HDD

In **NO HDD**, we define:



Diagram 3.21

In **NO HDD**, we define:

1. **BUZZER:** NO HDD buzzer.
ENABLE: To enable a buzzer when no HDD is detected.
DISABLE: To disable NO HDD buzzer.
2. **ALARM OUTPUT**
This will transmit a signal to another device. The setting of alarms are **NONE = not activated, 1 = output signal 1 transmits, 2 = output signal 2 transmits, 3 = output signal 3 transmits and 4 = output signal 4 transmits.** To change this, simply use the Jog Dial on the DVR.
3. **ALARM DURATION**
The length of time the buzzer remains active. This can be set from 1 sec to 99 seconds or permanent. The default value is 5 seconds.
4. **NETWORK ALARM**
YES: To enable network alarm.
NO: To disable network alarm.

5. **SEND EMAIL:**

YES: Send an email when no HDD has been found.

NO: Will not send an email when no HDD has been found.

The email settings can be set in the **NETWORK SETUP MENU**.

3.11.4 HDD FULL

In **HDD FULL**, we define:



Diagram 3.22

In **HDD FULL**, we define:

1. **BUZZER:** HDD FULL buzzer.

ENABLE: To enable a buzzer when HDD is full.

DISABLE: To disable HDD Full buzzer.

2. **ALARM OUTPUT**

This will transmit a signal to another device. The setting of alarms are **NONE = not activated, 1 = output signal 1 transmits, 2 = output signal 2 transmits, 3 = output signal 3 transmits and 4 = output signal 4 transmits**. To change this, simply use the Jog Dial on the DVR.

3. **ALARM DURATION**

The length of time the buzzer remains active. This can be set from 1 sec to 99 seconds or permanent. The default value is 5 seconds.

4. **NETWORK ALARM:**
YES: To enable network alarm.
NO: To disable network alarm.

5. **SEND EMAIL:**
YES: Send an email when HDD is full.
NO: Will not send an email when HDD is full.

The email settings can be set in the **NETWORK SETUP MENU**.

3.12 System Setup Menu



Diagram 3.23

Diagram 3.23 is a screen shot of the **SYSTEM SETUP MENU**. This menu is for setting up any additional options and restoring defaults to the digital recorder.

In the **SYSTEM SETUP MENU** the following fields are defined:

1. **SYSTEM VERSION:** Current system firmware version.
2. **SYSTEM VIDEO FORMAT:** NTSC or PAL. System can automatically detect the input signal type from camera 1 while system is booting up. Users do not need to set it up.

Note: Camera 1 input must be connected for the system to properly detect the video format.

3. **LOAD/SAVE CONFIGURATION:**

YES: Turn the Jog to enter the selection window. There are 4 options available: **CANCEL**, **DEFAULT**, **LOAD**, and **SAVE**. Use the Jog Wheel to scroll through these options and press **SELECT** to confirm your choice.

“CANCEL”: exits from selection window.

“DEFAULT”: restores the factory default values.

“LOAD”: uploads saved DVR configuration settings from USB.

“SAVE”: saves the current DVR configuration settings to USB device.

Note that a USB device must be inserted properly before choosing the “LOAD” or “SAVE” options. System will ask you to stop recording if you try to access any of these options while the system is recording.

NO: Press “ENTER” key to move to next option.

4. **UPDATE SYSTEM SOFTWARE:** Turn the jog to enter the selection window.
YES: Press **SELECT** on **YES** to update system software from USB.
NO: Press **SELECT** on **NO** to cancel updating.

Note:

System will ask you to stop recording if you try to update while system is recording.

USB device must be inserted properly before updating system software.

Do not remove USB device when you are updating system software; it may cause the machine to crash.

Power failure or machine being turn off during updating process may cause an abnormal start of the machine.

After upgrading system software, please do the following actions before recording:

- 1) Load System Default in **System Setup Menu**.
- 2) Delete disk in **Disk Setup Menu**.

5. **LANGUAGE**

System can be set in different languages. The available languages depend on the country or area, subject to change. Please consult your sales representative for the most updated information.

6. **QUICK PLAY**

Allows the user to automatically play back the most recent video after pressing the **PLAY** button.

ON: Enable quick play. Video starts playing from the set quick play time before the current time.

OFF: Disable quick play. Video starts playing from the last playback point.

TIME: Quick play time, from 1 ~ 59 min. The default value is 10 minutes.

***Note:** The recommended quick play time is at least 10 minutes. If you set a quick play time shorter than this, the video may not be played because the video files are not yet available.*

7. **SYSTEM PASSWORD ENABLE**

YES: Select **YES** to enable the password function.

NO: Select **NO** to disable the password function.

8. **PASSWORD** and **RIGHTS**: The different login passwords indicate the different level of users; no login name is necessary. Each number will replace the “*” sign when the digit is highlighted. Turn the Jog to change the selected digit of the password; press **ENTER** to go to next digit and **CALL** to go to the previous. The available digits are **1, 2, 3, 4, 5, 6, 7, 8** and **9** for the 9 and 16 CH model, whereas the 4 CH model uses only **1, 2, 3** and **4**. The system password is only used to set up the machine locally. The password for network connection can be found and set in the **NETWORK SETUP MENU**.

There are three system access levels and the default “none” access level. The following chart shows the rights of each level.

User Level and Right				
LEVEL RIGHT	LEVEL-3	LEVEL-2	LEVEL-1	NONE ACCESS
	ADMINISTRATOR	OPERATOR	GENERAL	---
DISPLAY	OK	OK	OK	OK
MODE	OK	OK	OK	OK
ZOOM	OK	OK	OK	OK
SELECT	OK	OK	OK	NO
SEQ	OK	OK	OK	NO
CALL	OK	OK	NO	NO
MENU	OK	NO	NO	NO
COPY	OK	NO	NO	NO
SEARCH	OK	NO	NO	NO
PLAY	OK	NO	NO	NO
STOP	OK	NO	NO	NO
REC	OK	NO	NO	NO
PAUSE	OK	NO	NO	NO
ALARM RESET	OK	OK	NO	NO

Note:

1. If the passwords of different levels are set the same, you will enter a higher level when you login. For example, you will login to ADMINISTRATOR level if the ADMINISTRATOR and GENERAL levels have the same password.
2. After exiting to the live camera view and waiting 60 seconds, the system will automatically log out to the None Access level.

4. Recording Overview

Before continuing with the Recording Overview please be sure to have reviewed Chapter 3, specifically the Camera & Schedule menus. You are now ready to begin setting up the machine for recording. This chapter will show you how to setup the recorder for three basic types of recording: Instant recording, scheduled recording, and event recording. **Instant recording (N)** is simple as it only requires pressing the Record button for recording, much like pressing the record button on a VCR. **Scheduled recording (1~8)** is based upon a set time period of when to begin & end the recording. **Event recording** consists of an alarm or motion event triggering the DVR to record on that event.

4.1 Instant (N) Recording Setup

Press the Record key to start recording immediately.



REC

When **REC** is pressed, the pictures being monitored will be recorded in the HDD.

The recording quality and recording speed can be set in the **CAMERA SETUP MENU**. To set the target camera for a particular recording speed (IPS) when using the instant record method, apply the changes to the last Time Period (TP) row labeled **N**.

A “R01” sign appears in the record status bar. The number following R signifies HDD number.

When the HDD is full, the machine will stop recording automatically or overwrite from the beginning of the HDD, depending on the setting in the **RECORD SETUP MENU**.



STOP

Press **STOP** key to stop instant recording.

The **STOP** key can only be used for instant recording mode. Schedule or event recording mode must be turned off in their respective menus.

Note:

If **STOP** key is pressed while machine is recording and playing video, the Play function will be disabled first. If **STOP** key is pressed twice, the DVR will stop recording completely.

4.2 Schedule Recording Setup

Set up the **DAY**, **START** time, **END** time and then turn **SET** to “ON” in the **SCHEDULE SETUP MENU**.

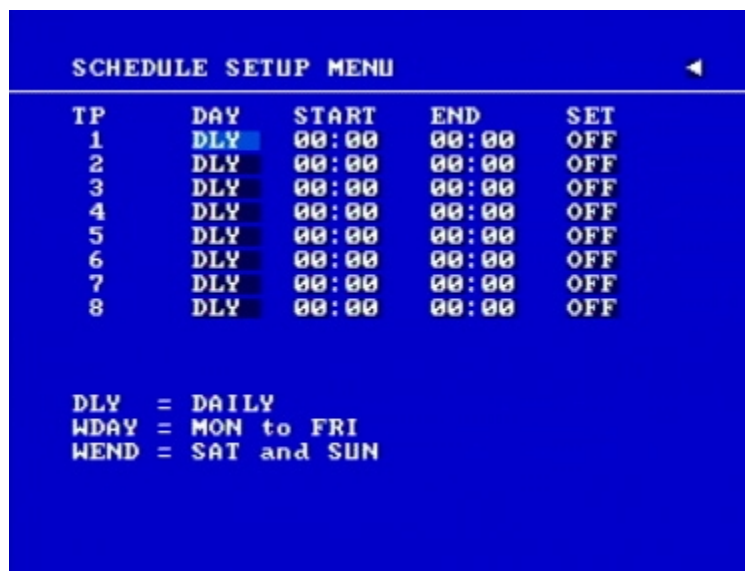

TP	DAY	START	END	SET
1	DLY	00:00	00:00	OFF
2	DLY	00:00	00:00	OFF
3	DLY	00:00	00:00	OFF
4	DLY	00:00	00:00	OFF
5	DLY	00:00	00:00	OFF
6	DLY	00:00	00:00	OFF
7	DLY	00:00	00:00	OFF
8	DLY	00:00	00:00	OFF

DLY = DAILY
WDAY = MON to FRI
WEND = SAT and SUN

Diagram 4.1

Please refer to **SCHEDULE SETUP MENU** for setting procedure and more details.

4.3 Event Recording Setup

We will now define two event recording types **ALARM** and **MOTION**. After the event recording is enabled, the DVR will start an event recording when an event occurs. For instance, when motion activity or alarm action is detected by the DVR it will begin recording at the specific IPS set in the Event column.

In order to start an event recording, you **MUST** perform the following:

1. First enable each event (alarm or motion) in its respective menu. For example, you can enable motion on Camera 2 in the **MOTION SETUP MENU** as shown below. You can enable multiple alarm or motion triggers.

MOTION SETUP MENU		
CAMERA 1	MOTION	ENABLE
CAMERA 2	SENSITIVITY	10 (HIGHEST)
CAMERA 3	LOG	ON
CAMERA 4	DURATION	05 SEC
CAMERA 5	ALARM OUTPUT	NONE
CAMERA 6	ALARM EMAIL	NO
CAMERA 7	ALARM NETWORK	NO
CAMERA 8	BUZZER	DISABLE
CAMERA 9	MOTION DELAY	0 LEVEL
CAMERA 10	MAIN MON	NO CHANGE
CAMERA 11	CALL MON	NO CHANGE
CAMERA 12	MATRIX MON 1	NO CHANGE
CAMERA 13	MATRIX MON 2	NO CHANGE
CAMERA 14	MATRIX MON 3	NO CHANGE
CAMERA 15	MATRIX MON 4	NO CHANGE
CAMERA 16		
SUMMARY		

Diagram 4.2

2. When the event is set, enter the **CAMERA SETUP MENU** to set the event recording speed (IPS) of the camera in the time period (TP) section.

CAMERA SETUP MENU				
CAMERA 1	TITLE	CH01	-----	
CAMERA 2	PTZ ID	011		
CAMERA 3	INSTALL/COVERT	ON /OFF		
CAMERA 4	SEQ(MAIN/CALL)	03/03 SECS		
CAMERA 5	REC QUALITY	SUPERIOR		
CAMERA 6				
CAMERA 7	REC SPEED & ACTION			
CAMERA 8	TP	NORMAL	EVENT	ACTION
CAMERA 9	1	7.5 IPS	30 IPS	ON
CAMERA 10	2	7.5 IPS	30 IPS	ON
CAMERA 11	3	7.5 IPS	30 IPS	ON
CAMERA 12	4	7.5 IPS	30 IPS	ON
CAMERA 13	5	7.5 IPS	30 IPS	ON
CAMERA 14	6	7.5 IPS	30 IPS	ON
CAMERA 15	7	7.5 IPS	30 IPS	ON
CAMERA 16	8	7.5 IPS	30 IPS	ON
CAMERA 16				
SUMMARY				
	N	7.5 IPS	30 IPS	ON

Diagram 4.3

3. Once the event and record and speed are set, you need to activate Instant Recording or set a time period (TP) in the **SCHEDULE SETUP MENU**. You can refer to the **SCHEDULE SETUP MENU** for time period configurations (Chapter 3.8).

Note:

1. If you want to record event activity (motion or alarm) **ONLY**, set the normal record speed as 0 IPS in the **CAMERA SETUP MENU**.
2. If the recording speed is changed while the machine is recording, the new recording speed will not take effect until recording is stopped completely.

4.4 ALARM INPUT RECORDING (Input trigger)

DVR provides a record function which is triggered by external signal via the 19th pin of the **ALARM INPUT / OUTPUT** port. When the record input signal is triggered constantly, DVR will start to record according to the speeds set on Time Period (TP) N. The system will stop recording when the record input signal is no longer triggered.

5. Playback Overview

Before continuing please be sure to have reviewed DVR Menu Setup (Chapter 3) and Recording Setup (Chapter 4). You are now ready to begin setting up the DVR for playback. This chapter will show you how to setup the recorder for basic playback.

5.1 Basic Playback

(1) Playback



Press the **PLAY** key to start playing back the stored image/audio. The video start time depends on the quick play setting in the **SYSTEM SETUP MENU**. The DVR is duplex, which means you can record and playback the same time.

(2) STOP



Press **STOP** key to stop playing back.

(3) Fast Forward/Reverse Playback



While in playback, turn the **Shuttle** dial clockwise to begin fast forward playback.

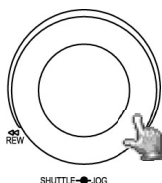

Turn the **Shuttle** dial counterclockwise to begin fast reverse playback.

The speed will be shown on the status bar of the bottom screen.

The available speeds are **2, 4, 6, 8, 16, 32, and 600**. You can either manually hold the shuttle dial in the position or press **ENTER** while holding the dial to lock the speed that is desired.

Press **PLAY** again to return normal play speed.

(4) Slow Forward/Reverse Playback



PAUSE

During playback mode, press **PAUSE** key to freeze the playing back picture.

Turn the **Shuttle** dial clockwise to begin slow forward playback.

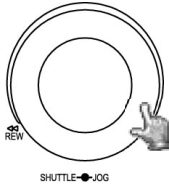

Turn the **Shuttle** dial counterclockwise to begin slow reverse playback.

The speed will show on the status bar of the bottom screen.

The available speeds are **1/2, 1/4, 1/8, 1/16, and 1/32**. You can either manually hold the shuttle dial in the position or press **ENTER** while holding the dial to lock the speed that is desired.

5.2 Search Playback



SEARCH

Press **SEARCH** key to enter the **SEARCH Menu**.

In the **SEARCH MENU**, Dial the **Jog** clockwise or counterclockwise to change subentry values.

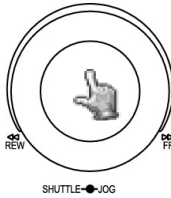

Press **ENTER** key to go to next subentry in search menu setting, and press the **CALL** key to go to previous subentry in search menu setting.

Press **MENU** to exit.

Press **SELECT** or the tilt wheel of the mouse to start search.



Diagram 5.1

(1) TIME / DATE Search Playback

The SEARCH MENU will show up after pressing **SEARCH** key. Select “**BY TIME / DATE**”, and then select the start date/time you want to search. Then, select the camera number and Disk Number to be searched. Lastly, press **SELECT** or the tilt wheel of mouse to start search.

Note:

If there is no video stored in the date/time specified, then the image will show the end of the last playback, and the display time on the status bar will show “??:??”.

(2) **EVENT Search Playback**

To search by “EVENT”, select “**BY EVENT**” for Method.

Set the Start and End Date/Time limits for the events to be searched.

Choose from 7 search filters: **ALARM, MOTION, VLOSS, A/M, A/V, M/V** and **A/M/V**

The indications of each filter are shown below.

EVENT	Indication
ALARM	Search ALARM events
MOTION	Search MOTION events
VLOSS	Search video loss events
A / M	Search ALARM and MOTION events
A / V	Search ALARM and video loss events
M / V	Search MOTION and video loss events
A / M / V	Search all events (ALARM, MOTION and video loss)

Then, select Camera number and Disk number for the events to be searched.

Lastly, press **SELECT** or tilt wheel of mouse to start search.

- (3) The search list shows up when **SELECT** is pressed. There are 16 events in one page, and “current page / total pages” shows in the top-right corner. Dial **Shuttle** clockwise or press **COPY** to move to the next page; dial **Shuttle** counterclockwise or press **CALL** to move to the previous page. If you would like to jump to a specific page directly, you can press **Search**, then dial **Jog** to the page, and press **Enter**. Dial the **Jog** to scroll through events on the list. When the desired event is highlighted, press **ENTER** to play the selected event.

The event types and number show on the second column of the search list.

SEARCH LIST OF DISK 01 P.001/201			
00001	M01	2005-06-27	16:33:05
00002	V03	2005-06-27	17:31:11
00003	V06	2005-06-27	19:47:25
00004	V08	2005-06-27	19:51:32
00005	PL	2005-06-28	06:32:17
00006	RTN	2005-06-28	09:58:41
00007	A04	2005-06-29	16:18:58
00008	T2	2005-06-29	17:54:35
00009	M04	2005-06-29	20:31:11
00010	A04	2005-06-29	23:23:11
00011	TN	2005-07-01	10:51:03
00012	M07	2005-07-01	16:21:11
00013	M03	2005-07-03	06:43:16
00014	PL	2005-07-03	12:51:51
00015	RT2	2005-07-03	13:01:44
00016	M01	2005-07-04	16:50:55

GO TO SEARCH PAGE 029

An: an Alarm event, n = the alarm number.

Dn: HDD overheated, n = drive number.

Fn: Fan fail, n = 1~3 fan number.

LH: (Logical Head): beginning of recording (earliest recorded date)

LUn: Local User login, n = 1~3; where 1 is Administrator, 2 is Operator and 3 is General.

Mn: a Motion event. n = the channel number.

PH: (Physical Head): beginning of physical hard drive space

PL: a Power Loss event.

RTn: a power ReTurn event in schedule recording mode, n = TP1~8

RTN: a power ReTurn event in Normal/instant recording mode

RUn: Remote User login through Internet Explorer, n = 1~6; user number.

Tn: begin schedule recording mode, n = TP 1~8

TN: begin Normal/instant recording mode.

Vn: a Video loss event, n = the channel number.

DLB: Begin DayLight saving time.

DLE: End DayLight saving time.

S1: Switch to HDD1.

S2: Switch to HDD2.

The last two columns are the date and time of event.

6. Copying Video

Before continuing please be sure to have reviewed the preceding chapters. You are now ready to copy an image or video from the DVR. This chapter will show you how to copy a still image or movie from the recorder.

Insert the USB pocket drive into the USB slot on the front panel.

USB SLOT:

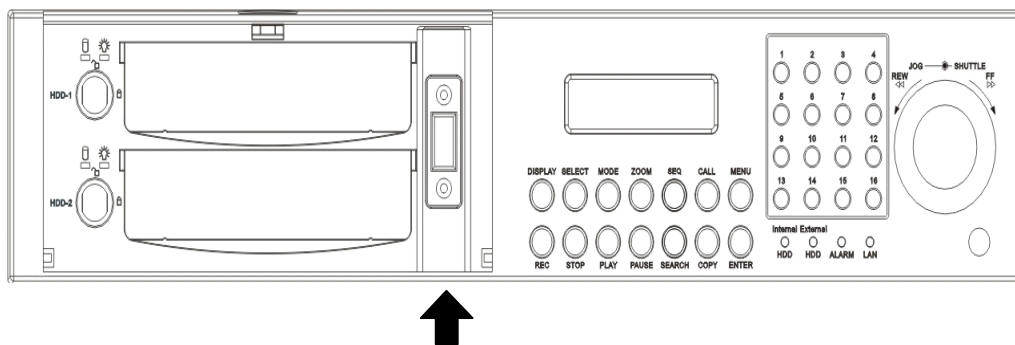

Digital Video Recorder allows users to copying image (video) from a selected camera or copying DVR Viewer, which is the image (video) player. The camera title will be displaying at the top of the screen.



COPY

Press **COPY** key to enter the Copy Menu.



Diagram 6.1

In the **COPY MENU**, we define:

1. **COPY**

Select **Image** for copying images/video to movie file.

Select **Viewer** for copying DVR Viewer player.

2. **DISK NO**

Disk number you wish to copy from.

3. **CAMERA NO**

Camera channel number. You can select an individual camera or ALL cameras.

If you select ALL cameras while you are recording, DVR will stop recording temporarily, until copy process is terminated.

4. **START DATE & TIME:** The start time of video you want to copy.

END DATE & TIME: The end time of video you want to copy.

5. **SIZE OF SELECTED IMAGE: __ MB (PRESS PLAY TO ESTIMATE)**

The system can estimate the file size of the selected image you wish to copy. Simply press **PLAY** key after you have selected start date/time and end date/time. If file size is large, estimate time may take a while.

6. DEVICE

The media you want to store the file to.

After choosing copy settings, press **SELECT** or the tilt wheel of the mouse to begin copy.

1. Every 30-minutes of data will be saved as one file. However, if this file size exceeds 2G, DVR will automatically split it into smaller video clips that will be copied individually. The current segment and completion percentage are displayed at the bottom of the screen.
2. While in playback, pressing **COPY** button will set a start and end time in the Copy Menu for span of 1 minute. (For example, Start copy point is 10-10-2005 10:00:00 and end copy point will be 10-10-2005 10:01:00) You can change either value in the Copy Menu to suit your needs.

6.1 Viewing a Copied File

1. In order to view video copied from the DVR, you will also need to download the DVR Viewer file. Insert a USB pocket drive into the DVR. Press **COPY** button to enter the Copy Menu. In the Copy Menu choose “Viewer” at the top of the screen. Then press **SELECT** button to copy the viewer to the USB.
2. Remove the USB and insert it into your computer.
3. Open up My Computer in Windows. Open the Removable Drive. You will see the files you archived as well as the DVR Viewer you just downloaded.
4. Open the DVRViewer.exe and click on “Load File.”
5. Choose from one of the archived video files (.arv) that you copied from the DVR and click Open.
6. The video will begin playing back. To save it as a Windows compatible video file, click on “Save to Avi...”, choose the location you want to save it in, and click Save.

Please note that if you choose ALL CAMERAS to copy, you will need to download the HDD Reader program (http://www.everfocus.com/support_download.asp) in order to playback the file copied. DVR viewer is only capable of displaying a single camera, not all cameras.

7. Call Overview

This chapter will give you basic details on how to setup the **CALL MENU** on the DVR. Press the **CALL** key and the **CALL MENU** will pop up as below.



Diagram 7.1

In **CALL MENU**, you can do the following settings for the selected monitor:

1. **SEQ:** Sequence display on the call monitor. Press **SEQ** key or Middle wheel of mouse to switch the sequence status “**ON**” or “**OFF**”.
2. **OSD:** Channel name display on the call monitor. Press **DISPLAY** key or right click the mouse to switch the **OSD** status “**ON**” or “**OFF**”.
3. **CAMERA:** The current display camera in the call monitor. Press **Channel NO** or slide wheel of mouse to set display camera.
4. **Sequence dwell time setting**

Turn the jog dial with **SEQUENCE DWELL TIME MENU** highlighted to enter the menu.

SEQUENCE DWELL TIME MENU				
CAMERA	MON 1	MON 2	MON 3	MON 4
1	03	03	03	03
2	03	03	03	03
3	03	03	03	03
4	03	03	03	03
5	03	03	03	03
6	03	03	03	03
7	03	03	03	03
8	03	03	03	03
9	03	03	03	03
10	03	03	03	03
11	03	03	03	03
12	03	03	03	03
13	03	03	03	03
14	03	03	03	03
15	03	03	03	03
16	03	03	03	03

UNIT : SECOND(S)

Diagram 7.2

Dial jog to set sequence dwell time for each camera on matrix monitor 1~4. Sequence dwell time can be set from 00 to 99 seconds. Press **Enter/Call** key to go next/previous selection.

8. Screen Display Setting & Mode

In a full screen display, press **SELECT** key to pop up the display adjustment window as below:



Diagram 8.1

In the screen display setting menu, we define:

1. **CAMERA:** The current camera. (cannot be changed)
2. **BRIGHTNESS:** The brightness percentage of the current camera; from 0% to 100%.
3. **CONTRAST:** The contrast percentage of the current camera; from 0% to 100%.
4. **COLOR:** The color percentage of the current camera; from 0% to 100%.
5. **SHARPNESS:**

By turning **SHARPNESS ON**, the image will become sharper and clearer in live mode. This option is suitable for indoor use.

When SHARPNESS is **OFF**, the image becomes blurred in an indoor environment. However, this setting is suitable for outdoor use. If image flickers from a bright, outdoor environment, this can be reduced by turning SHARPNESS **OFF**.

The selected item will show in red color bar. Use **Jog** to increase or decrease the value. Press **ENTER** to confirm the setting value and move to next item. After finished setting, press **SELECT** or **MENU** key to save and exit the screen.

1. In a full screen display, pressing **ZOOM** button from front panel will allow you to zoom in the image. Dial Jog to move upward, downward, leftward or rightward of the zoomed in image. Press ENTER key to change direction between or . Press **ZOOM** button again to exit.
2. In a multi screen display, pressing **ZOOM** button from front panel will enable you to adjust the screen position. Dial Jog to move up and down or left and right. Press ENTER key to change direction between or . Press **ZOOM** button again to exit.

8.1 Mode Button

Press **MODE** to switch 4, 7, 9, 10, 13, 16 and PIP (picture in picture) displays for Live and Playback mode.

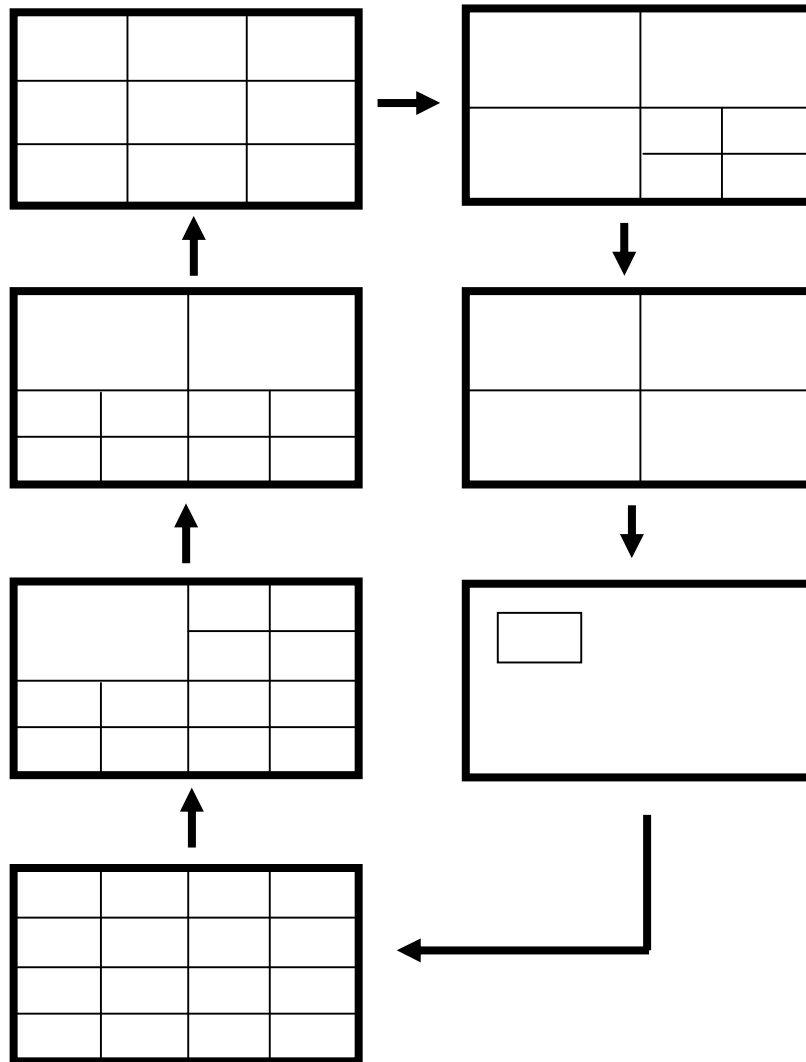

9. Firmware Upgrade

This chapter will give you detailed instruction on how to upgrade the DVR's software. You can check the System Menu for the current firmware version. Please check our website (http://www.everfocus.com/support_bulletins.asp) for the latest firmware updates.

1. Copy the .ETW file to your USB pocket drive from your computer.
2. Insert the USB pocket drive in to the top USB slot on the front panel of the DVR. When inserting the USB, make sure the direction of insertion is correct.
3. If you are in Record mode hit the STOP button before entering the Menu to stop recording.
4. If you cannot stop recording after pressing STOP button, please enter Schedule Setup Menu and turn all schedules off, then exit completely from Menu.
5. Once you have stopped any type of recording on the DVR, you are ready to upgrade.
6. Press the MENU button and use the Jog Dial to go to System Menu.
7. Press ENTER until "System Upgrade" is highlighted, then change NO to YES using the Jog wheel.
8. Choose "YES" again and press SELECT to confirm.
9. You will see "Updating 1/3" at the bottom-left of the screen. Status will progress from 1/3 -> 2/3 -> 3/3.
10. Once the message "Success, Please Reboot" pops up, highlight "Load/Save Configuration and change it from NO to YES.
11. Select DEFAULT and press SELECT.
12. When you see "Success" at the bottom of the screen, press the menu button twice to log out of the menu and remove USB pocket drive. Then turn the DVR's power off, wait 3 seconds, and turn it back on.
13. After the system reboots, you can check the current version by going back to System Menu.

10. Networking Overview

This chapter will try to give you a detailed instruction on how to network the DVR. Before we begin the process of networking your digital recorder we should have a working knowledge of what a network is and how it works. This will be a helpful in completing the networking process.

10.1 Introduction to TCP/IP

TCP/IP is the suite of protocols used by the Internet and most LANs (Local Area Networks) throughout the world. In TCP/IP, every host (computer or other communications device) that is connected to the network has a unique IP address. By doing this you are giving your device a unique address similar to the address of your house. An IP address is composed of four octets (numbers in the range of 0 to 255) separated by decimal points. The IP address is used to uniquely identify a host or computer on the LAN. For example, one computer on a network could have an IP address of 192.168.1.127.

You should avoid giving two or more computers the same IP address by using the range of addresses that are reserved for private, local area networks; this range of IP addresses usually begins with 192.168. The first three octets of an IP address should be the same for all computers in the local area network. For example, if a total of 253 computers exist in a single LAN, the IP addresses could be assigned starting with 192.168.1. x , where x represents a number in the range of 2 to 254.

10.2 Subnet Masks

Each host in a LAN has a subnet mask. The *subnet mask* is an octet that uses the number 255 to represent the network address portion of the IP address and a zero to identify the host portion of the address. For example, the subnet mask 255.255.255.0 is used by each host to determine which LAN or class it belongs to. The zero at the end of the subnet mask represents a unique host within that network. Basically the subnet mask represents the city you live in for your home address, but in this case you are stating the network you belong to.

10.3 Gateway Address

Each host in a LAN has a gateway. A gateway address is composed of four octets (numbers in the range of 0 to 255) separated by decimal points. The gateway address is used to uniquely

identify a host or computer on the LAN which assigns the IP addresses to your network. For example, a Linksys router has an IP address of 192.168.1.1. If you were using this type of router within your LAN, then your gateway would be the IP address of the Linksys router. The reason this would be your gateway is because the Linksys is assigning the IP addresses for your network therefore the Linksys would be the gateway to your network. This is similar to the zip code of your address.

10.4 Virtual Ports

A **port number** represents an endpoint or "channel" for network communications. Port numbers allow different applications on the same computer to utilize network resources without interfering with each other. Port numbers most commonly appear in network programming, particularly socket programming. Sometimes, though, port numbers are made visible to the casual user. For example, some Web sites a person visits on the Internet use a URL like the following:

`http://www.everfocus.com:8100/`

In this example, the number 8100 refers to the port number used by the Web browser to connect to the Web server. Normally, a Web site uses port number 80 and this number need not be included with the URL (although it can be). In IP networking, port numbers can theoretically range from 0 to 65535. Most popular network applications, though, use port numbers at the low end of the range (such as 80 for HTTP). This could be similar to the front door of your house. Without the door to the house being open you could not enter it. This is the same case with ports on a network. If the ports for a specific IP address are not open then you could not gain access to that IP address or what it is addressing.

Note: The term port also refers to several other aspects of network technology. A port can refer to a physical connection point for peripheral devices such as serial, parallel, and USB ports. The term port also refers to certain Ethernet connection points, such as those on a hub, switch, or router.

10.5 Pre-Installation

Before we begin with the installation we must ask ourselves a few questions in order to figure out where to begin with networking our DVR's.

Do you have Hi-speed Internet? _____

There are many types of high speed Internet available. Three commonly used ones are T1, Cable, and DSL (in order of speed).

- **Note: Everfocus suggests having a minimum upload speed of 256KBps. This can be addressed by the Internet Service Provider.**

Who is your Internet provider? _____

- Please confirm that your internet service provider that our upload speed is at least 256KBps.

What type of modem/router do you have? _____
Modem/router model name/ #

The modem/router was either installed by your Internet service provider or purchased by you to establish a connection to the Internet. A router is installed to allow multiple computers to access the Internet through the same external IP address. It in turn assigns different internal IP addresses to local computers for this specific purpose.

Do you have a static IP address? _____

A Static IP address means you use the same IP address every time you log on to the Internet. With a static IP address, other Internet users always know the identity of your computer and can easily connect with it. That way, you can host a website, email server, or other type of server connection. Everfocus suggest using a static IP address. If your Internet provider does not offer a static IP address you have the option to use a dynamic IP address. This will be explained in more detail later on in the chapter.

Do you have a dynamic IP address? _____

A Dynamic IP address means your IP address changes each time you make a connection to the Internet. We recommend asking your Internet service provider for a Static IP address. If this is not a possibility, you may purchase a router (we suggest a Linksys or D-link router) which supports DDNS. DDNS is a Dynamic Domain Name Server, a service that provides a central (public) database where DNS information can be stored and retrieved. It allows those using a dynamic IP address to be registered centrally so users can connect to it by name.

What type of DVR are you installing? _____

Everfocus EDR series: EDR 410, 810, 920, 1620, 1640, or 1680

Everfocus EDSR series: EDSR 110, 400H, 400M, 400, 900, or 1600

10.6 What Type of Network Connection do you have?

Everfocus DVR's can operate using three distinct types of networking connections.

1. **Simple One to One Connection:** A simple one to one connection is the most simple network connection. Basically it is a connection between a Computer and Another Computer or in this case a DVR using a cross-over cable.
2. **Direct High Speed Modem Connection:** A direct high speed modem connection is a network connection from the modem directly to a computer or in this case the DVR.
3. **Router or LAN Connection –** A local area network connection either requires a router or a pre-existing LAN connection. Typically this type of connection is the most commonly used application. A router allows multiple computers and DVR's to access each other as well as the Internet. It assigns different internal IP addresses to the computers.

10.7 Simple One to One Connection

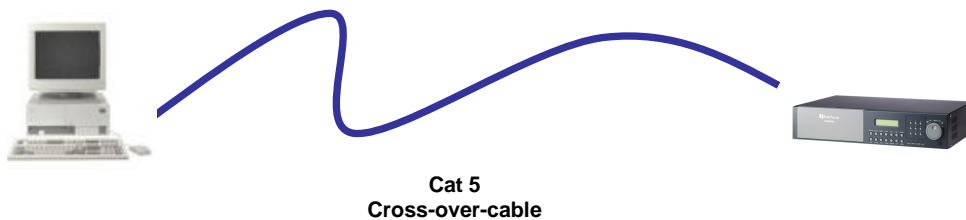

Crossover Ethernet Cable Pin outs:

The Diagram below shows the pin configurations for a cross over cable.

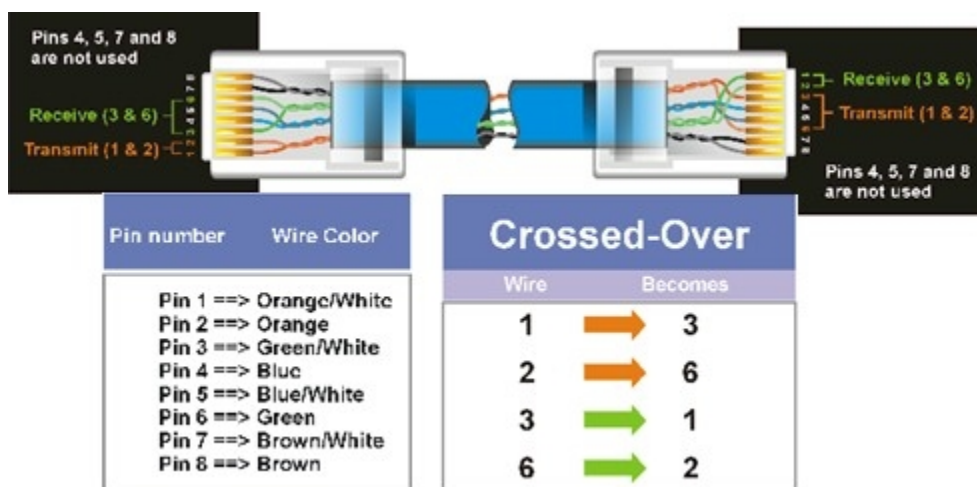
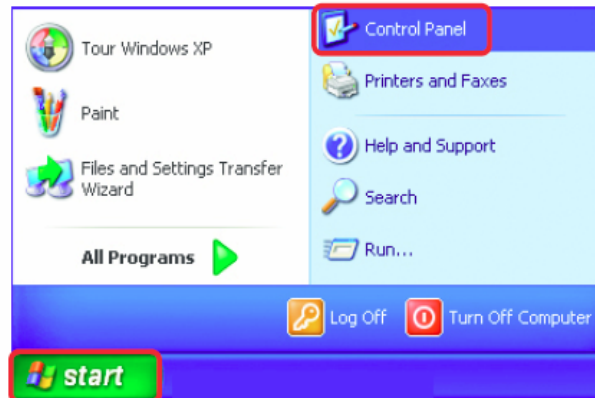

Diagram 10.1

Connection Procedure:

- The First step is to purchase or make a cross over cable. We recommend purchasing one if you have never made a cross over cable. Please remember you can not use a straight through network cable for this application
- Once you have a cross over cable plug one end into the LAN port on the back of the recorder and the other into the network card on the back of the computer.
- Now Log into the Everfocus DVR menu and using the jog dial from the previous chapter go to the Network Setting Menu.
- Assign an IP address of 192.168.001.003 to the DVR, a Subnet mask of 255.255.255.000, and a default gateway of 192.168.001.001.
- The next step is to get the computer onto the same network to do this you will need administrator access to your windows machine.
- To assign a static IP address in Windows 2000/XP.

- Go to **Start**
- Double-click on **Control Panel**



- Double-click on **Network Connections**

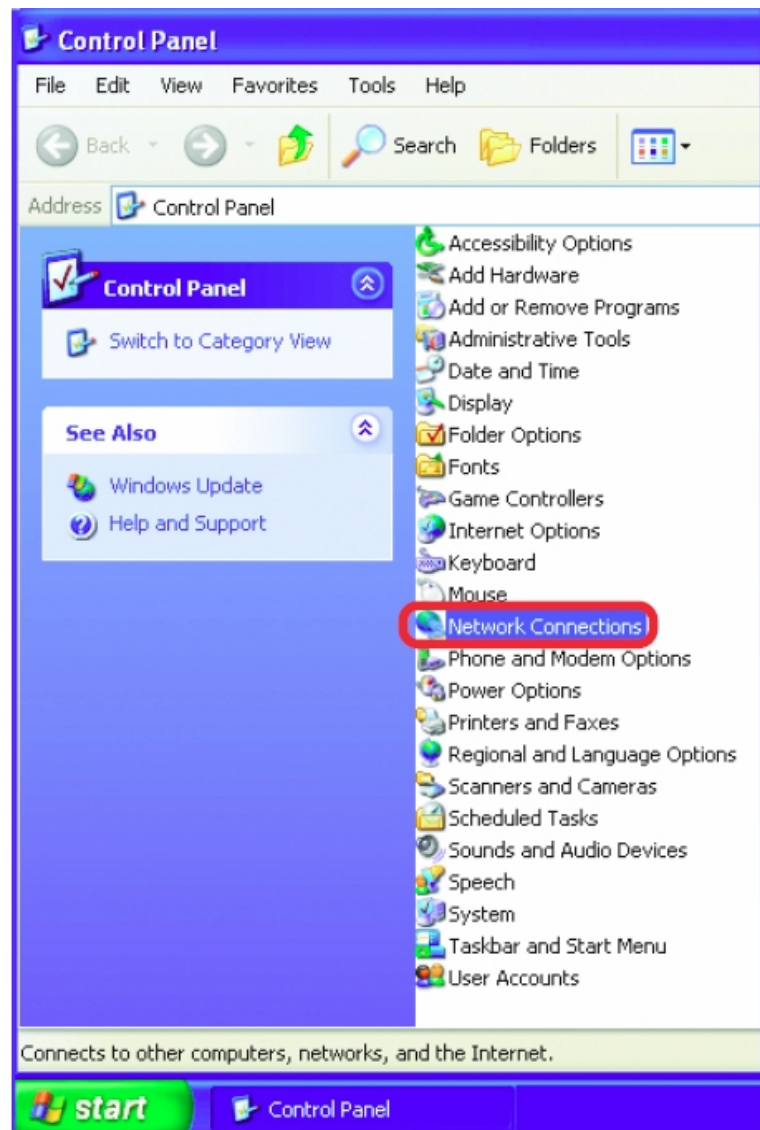

- Right-click on **Local Area Connections**

- Double-click on **Properties**

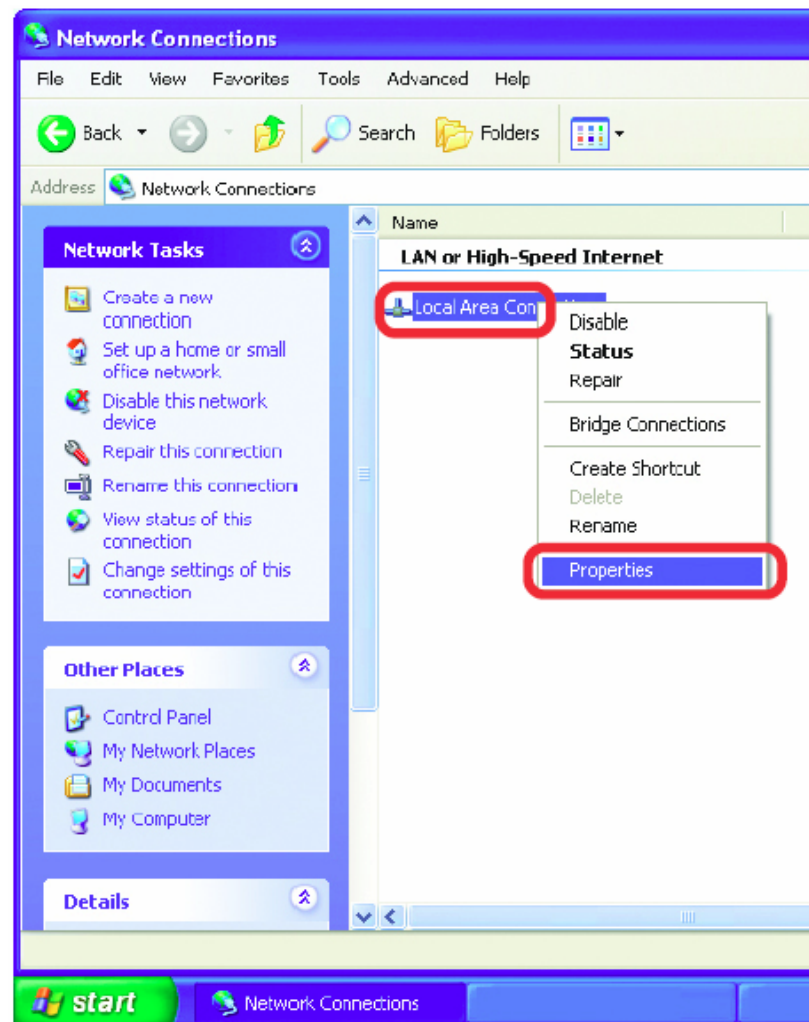

- Click on **Internet Protocol (TCP/IP)**

- Click **Properties**

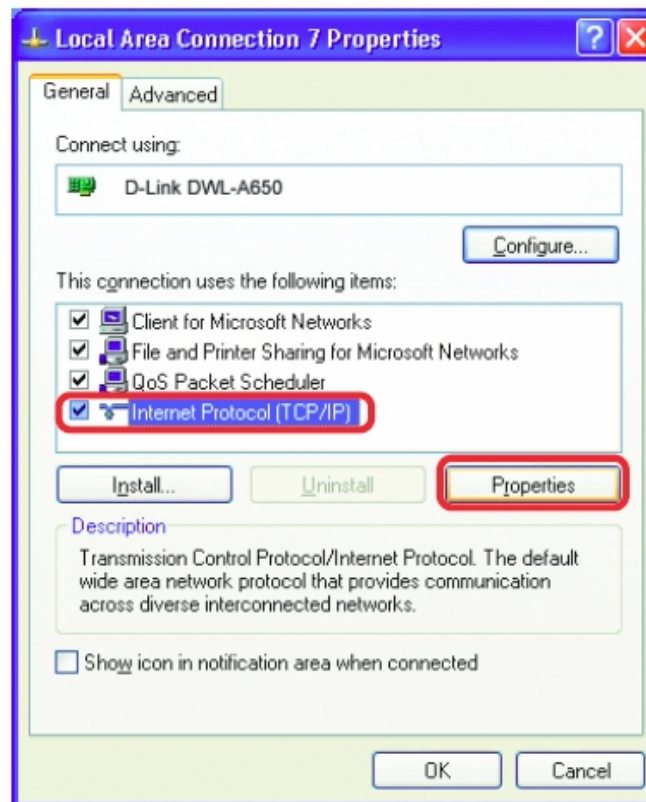

- Input your **IP address and subnet mask**. (The IP Addresses on your network must be within the same range.)

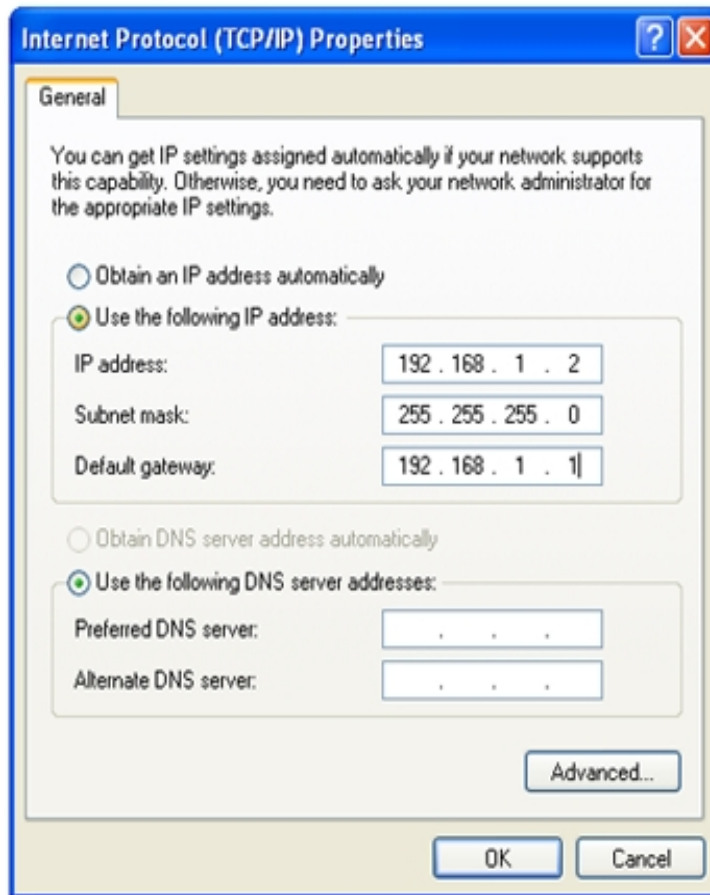

- Once you have reached this point click ok and restart both the computer and the digital recorder.
- To access the DVR from the computer simply open Internet Explorer and in the address bar type:

<http://192.168.1.3>

ActiveX

ActiveX is a component from Microsoft that enables interactive content for a web site. With ActiveX, Web pages are able to include multimedia, interactive programs, and sophisticated applications that give user the same experience as a high-quality CD-ROM title. ActiveX provides the programming necessary to run these "active" Web sites.

When accessing the web page, it installs the activeX control that allows you to run the application needed for that web page.

Such is the case for the DVR.. The EDR series of recorders require that ActiveX be enabled on Internet Explorer in order to fully view the cameras. If the ActiveX options on Internet Explorer are not on, then the cameras will not be displayed.

Enabling ActiveX

- Open the Control Panel from the Start menu of the computer
- Click on Internet Options

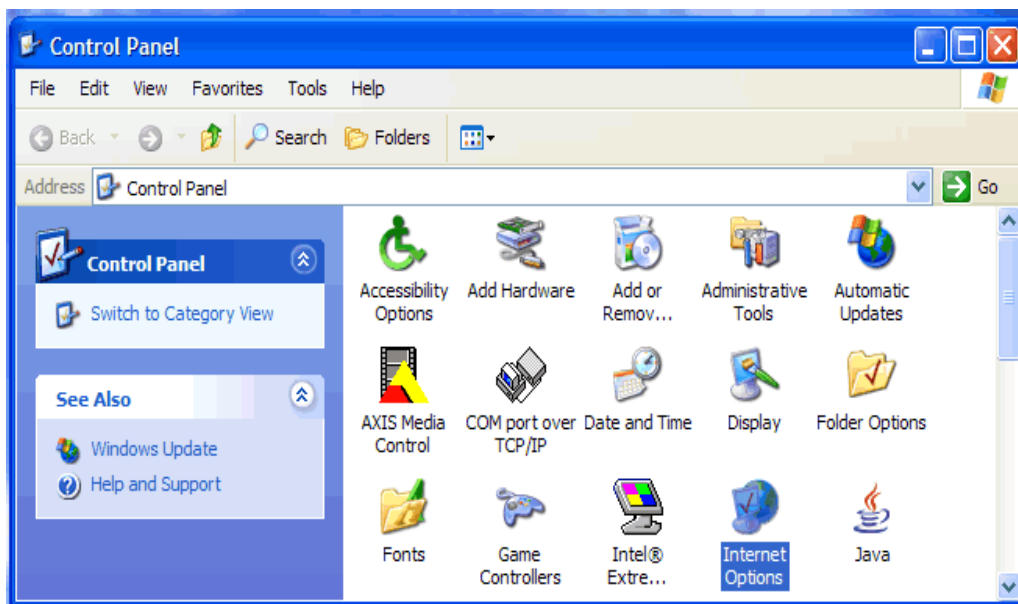

- On Internet Options click on the SECURITY tab.
- On the Security tab, click on CUSTOM LEVEL at the bottom.

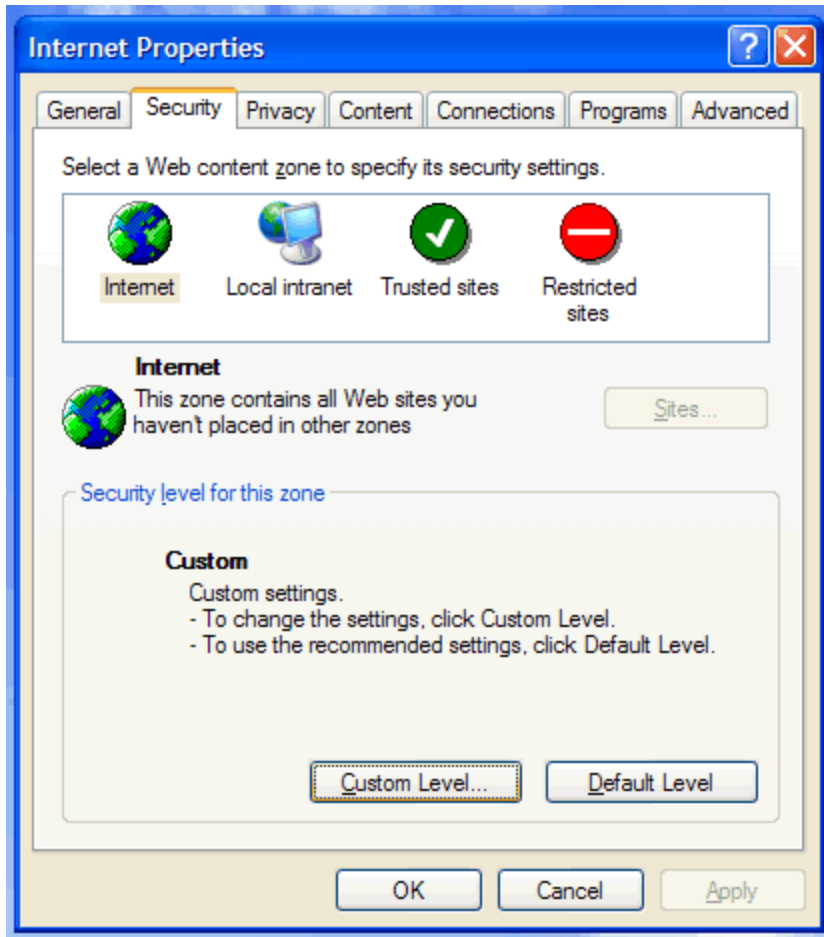

- Once in CUSTOM LEVEL, Scroll down to ACTIVE X CONTROLS AND PLUG-INS. Set the Following Settings:

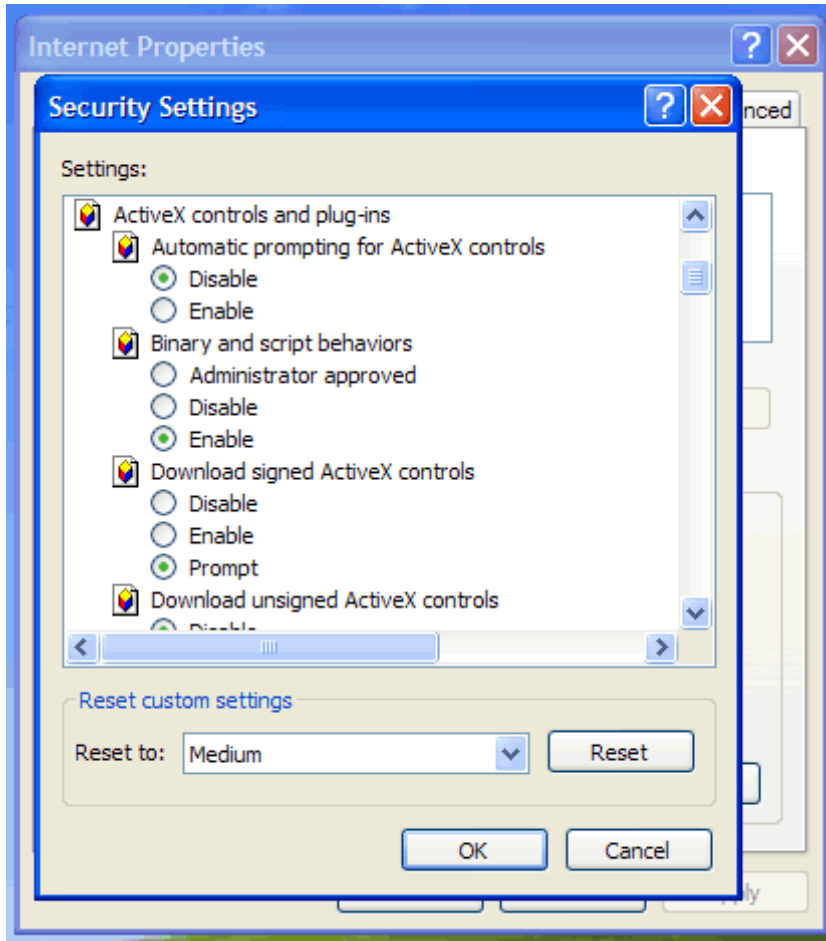

- Download Signed ActiveX controls: Prompt
- Run ActiveX controls and plug-ins: Enable
- Script ActiveX controls Marked safe for scripting:: Enable

- If you are still not able to load the active X control, change RESET CUSTOM SETTINGS to low and then click on RESET.
- Once Enabled, Click on OK on the Security Settings window. Then click on apply on the Internet Options window and finally click OK.

10.8 Direct High Speed Modem Connection

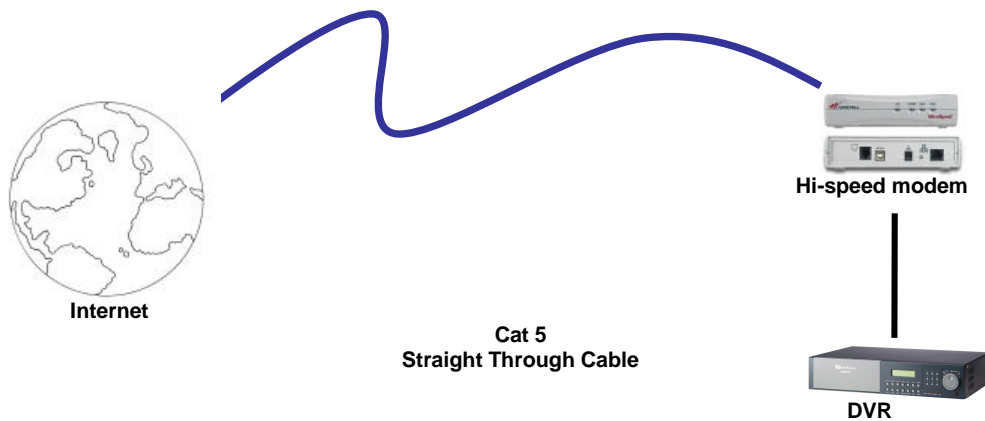

Straight Through Ethernet Cable Pin outs:

The Diagram below shows the pin configurations for a straight cable.

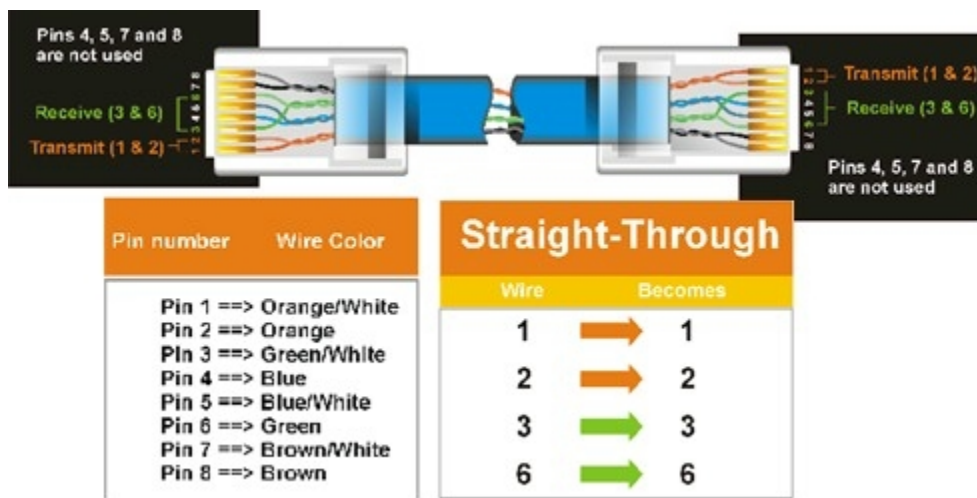

Diagram 10.2

Connection Procedure:

- The First step is to purchase or make a straight through cable. We recommend purchasing one if you have never made a straight through cable. Please remember you can not use a cross over network cable for this application
- Once you have a straight through cable plug one end into the LAN port on the back of the recorder and the other into the high speed modem.

- Now Log into the Everfocus DVR menu and using the jog dial from the previous chapter go to the Network Setting Menu.
- Assign the Static IP address which you obtained from the internet service provider to the DVR, the Subnet mask from the internet service provider to the DVR, and the default gateway of the internet service provider.
 - ***Note: If you have a dynamic IP address this type of connection can work directly through the DVR directly. The DVR can be used as a DHCP client. Therefore, it can receive a dynamic IP address.***
- Once you have reached this point click ok and restart both the computer and the digital recorder.
- To access the DVR from a computer simply open Internet Explorer and in the address bar type:

http:// and the IP address of your internet service provider.

10.9 Router or LAN Connection

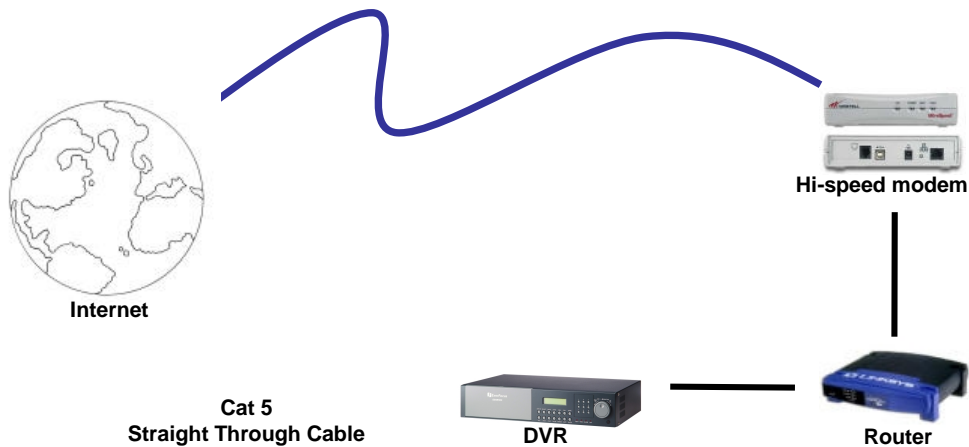

Straight Through Ethernet Cable Pin outs:

The Diagram below shows the pin configurations for a straight cable.

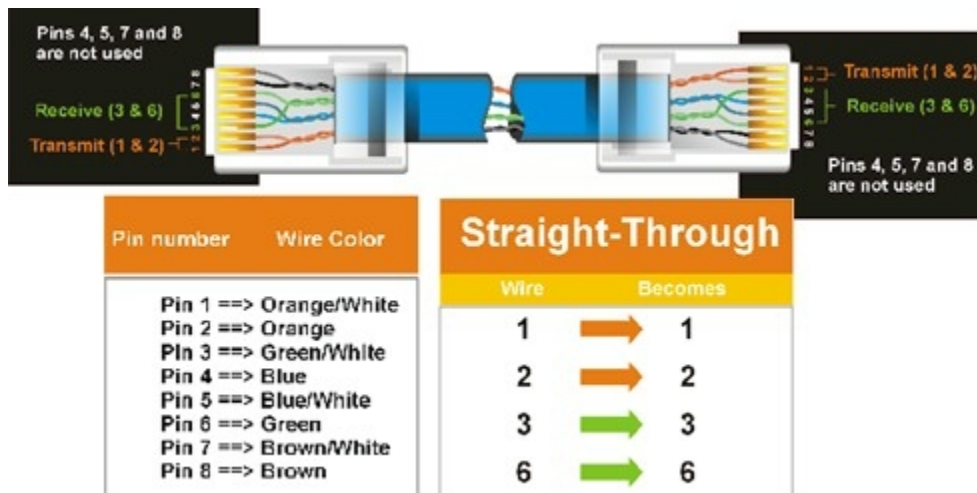

Diagram 10.3

Connection Procedure:

- The First step is to purchase or make a straight through cable. We recommend purchasing one if you have never made a straight through cable. Please remember you can not use a cross over network cable for this application

- Once you have a straight through cable plug one end into the LAN port on the back of the recorder and the other into the router.
- Now Log into the Everfocus DVR menu and using the jog dial from the previous chapter go to the Network Setting Menu.
- If you have a Linksys Router:
 - Assign an IP address of 192.168.001.050 to the DVR, a Subnet mask of 255.255.255.000, and a default gateway of 192.168.001.001.

If you have a D-Link Router:

- Assign an IP address of 192.168.000.050 to the DVR, a Subnet mask of 255.255.255.000, and a default gateway of 192.168.000.001.

If you have a pre-existing LAN:

- Go to a Computer on the pre-existing network and do the following:
 - Go to Start, then Run and type cmd and click on OK.
- Then hit enter, type ipconfig and press enter this will give you the information you will need.

```

C:\WINDOWS\system32\cmd.exe
Microsoft Windows XP [Version 5.1.2600]
(C) Copyright 1985-2001 Microsoft Corp.

C:\Documents and Settings\Arai>ipconfig

Windows IP Configuration

Ethernet adapter Local Area Connection:

    Connection-specific DNS Suffix  . : 
    IP Address . . . . .               : 
    Subnet Mask . . . . .              : 
    Default Gateway . . . . .          : 

C:\Documents and Settings\Arai>_
  
```

- Use the prior step to assign an IP address. For example, if you got the IP address from the computer of 192.168.002.101. Assign the DVR's IP address as 192.168.002.050. Now Copy the subnet mask and default gateway information you got from the prior step off the computer to the DVR.

- ***Note: Make sure the modem is in bridge mode. If your Internet Service Provider is BellSouth you may have a modem/router. BellSouth provides a Westell modem that includes a built-in router. You will need to disable the router functionality.***
- The next step is to open ports within your router. Open virtual ports in the router (Log into the router using a PC)
 - EDR Ports to open: 80, 1600,1601,1602,1603, 37260, 37261, 37262, 37263
 - ***Note: If your Internet service provider blocks port 80 you must use a different port to access the DVR through the DVR's Network Menu Setup.***
 - ***Note: If you wish to have multiple users log into the DVR please open a range for the control and data ports on your router. For example if you would only like 4 clients to connect to the DVR open 1600-1603 and 37260 ~ 37263***
- If you have a Dynamic IP address and have open the ports simply go to Chapter 13 to Configure DDNS.
- Once you have reached this point and you have restarted the digital recorder.
- To access the DVR from a computer simply open Internet Explorer and in the address bar type:

http:// and the IP address of your internet service provider.
- ***Note: If your Internet service provider blocks port 80 you may use a different port to access the DVR through the DVR's Network Menu Setup.***

11. Linksys Port Forwarding

This chapter will cover a few simple configurations for the Linksys router. Please understand we do not support this product and will not give tech support on it. If you need Technical support on this router you must call Linksys. This Chapter is to offer some help to the installer and end user nothing more.

To access the Web-based Utility, launch Internet Explorer or Netscape Navigator, and enter the Router's default IP address, **192.168.1.1**, in the *Address* field. Then, press **Enter**. A password request page will appear. (Non-Windows XP users will see a similar screen.) Leave the *User Name* field blank. The first time you open the Web-based Utility, use the default password **admin**. (You can set a new password from the Administration tab's *Management* screen.) Click the **OK** button to continue.



The first screen that appears displays the Setup tab. This allows you to change the Router's general settings. Change these settings as described here and click the **Save Settings** button to apply your changes or **Cancel Changes** to cancel your changes.

LINKSYS®
A Division of Cisco Systems, Inc. Firmware Version: 1.05.00

Etherfast® Cable/DSL Router BEFSR41 V3

Applications & Gaming | Setup | Security | **Applications & Gaming** | Administration | Status

Port Range Forwarding | Port Triggering | UPnP Forwarding | DMZ

Port Range Forwarding

Port Range					
Application	Start	End	Protocol	IP Address	Enabled
dvr1	80	80	Both	192.168.1.100	<input checked="" type="checkbox"/>
dvr2	1600	1610	Both	192.168.1.100	<input checked="" type="checkbox"/>
dvr3	37260	37270	Both	192.168.1.100	<input checked="" type="checkbox"/>
	0	0	Both	192.168.1.0	<input type="checkbox"/>
	0	0	Both	192.168.1.0	<input type="checkbox"/>
	0	0	Both	192.168.1.0	<input type="checkbox"/>
	0	0	Both	192.168.1.0	<input type="checkbox"/>
	0	0	Both	192.168.1.0	<input type="checkbox"/>
	0	0	Both	192.168.1.0	<input type="checkbox"/>
	0	0	Both	192.168.1.0	<input type="checkbox"/>

Port Range Forwarding

Port Range Forwarding can be used to set up public services on your network. When users from the Internet make certain requests on your network, the Router can forward those requests to computers equipped to handle the requests. If, for example, you set the port number 80 (HTTP) to be forwarded to IP Address 192.168.1.2, then all HTTP requests from outside users will be forwarded to 192.168.1.2. **It is recommended that the computer use static IP address.**

You may use this function to establish a web server or FTP server via an IP Gateway. Be sure that you enter a valid

[More...](#)

CISCO SYSTEMS

[Save Settings](#) [Cancel Changes](#)

The Applications and Gaming Tab allows you to set up public services on your network, such as web servers, ftp servers, e-mail servers, or other specialized Internet applications. (Specialized Internet applications are any applications that use Internet access to perform functions such as videoconferencing or online gaming. Some Internet applications may not require any forwarding.)

To forward a port, enter the information on each line for the criteria required. Descriptions of each criterion are described here.

LINKSYS
A Division of Cisco Systems, Inc. Firmware Version: 1.05.00

Etherfast® Cable/DSL Router BEFSR41 V3

Applications & Gaming

Setup Security Applications & Gaming Administration Status

Port Range Forwarding Port Triggering UPnP Forwarding DMZ

Port Range Forwarding

Port Range					
Application	Start	End	Protocol	IP Address	Enabled
dvr1	80	80	Both	192.168.1.100	<input checked="" type="checkbox"/>
dvr2	1600	1610	Both	192.168.1.100	<input checked="" type="checkbox"/>
dvr3	37260	37270	Both	192.168.1.100	<input checked="" type="checkbox"/>
	0	0	Both	192.168.1.0	<input type="checkbox"/>
	0	0	Both	192.168.1.0	<input type="checkbox"/>
	0	0	Both	192.168.1.0	<input type="checkbox"/>
	0	0	Both	192.168.1.0	<input type="checkbox"/>
	0	0	Both	192.168.1.0	<input type="checkbox"/>
	0	0	Both	192.168.1.0	<input type="checkbox"/>
	0	0	Both	192.168.1.0	<input type="checkbox"/>

Port Range Forwarding can be used to set up public services on your network. When users from the Internet make certain requests on your network, the Router can forward those requests to computers equipped to handle the requests. If, for example, you set the port number 80 (HTTP) to be forwarded to IP Address 192.168.1.2, then all HTTP requests from outside users will be forwarded to 192.168.1.2. **It is recommended that the computer use static IP address.**

You may use this function to establish a web server or FTP server via an IP Gateway. Be sure that you enter a valid

[More...](#)

Save Settings Cancel Changes

CISCO SYSTEMS

Application - In this field, enter the name you wish to give the application. Each name can be up to 12 characters.

Start/End - This is the port range. Enter the number that starts the port range under **Start** and the number that ends the range under **End**.

Protocol - Enter the protocol used for this application, either **TCP** or **UDP**, or **Both**.

IP Address - For each application, enter the IP Address of the PC running the specific application.

Enable - Click the **Enable** checkbox to enable port forwarding for the relevant application.

Change these settings as described here and click the **Save Settings** button to apply your changes or **Cancel Changes** to cancel your changes.

Example: (Here we open ports for up to 10 clients)

DVR	80 to 80	Both	192.168.1.50	Enable
DVR	1600 to 1610	Both	192.168.1.50	Enable
DVR	37260 to 37270	Both	192.168.1.50	Enable

- ***Note: If your Internet service provider blocks port 80 and you are using a different port to access the DVR through the DVR's Network Menu Setup please open those specific ports in this section of the router.***
- ***Note: If you wish to have multiple users log into the DVR please open a range for the control and data ports on your router. For example if you would only like 4 clients to connect to the DVR open 1600-1603 and 37260 ~ 37263***

The following is the address you would type:

http:// IP address of your internet service provider: 8100

12. D-Link Port Forwarding

This chapter will cover a few simple configurations for the D-Link router. Please understand we do not support this product and will not give tech support on it. If you need Technical support on this router you must call D-Link. This Chapter is to offer some help to the installer and end user nothing more.

Whenever you want to configure your network or the DI-624, you can access the Configuration Menu by opening the web-browser and typing in the IP Address of the DI-624. The DI-624 default IP Address is shown at right:

- Open the web browser
- Type in the **IP Address** of the Router (<http://192.168.0.1>)

Note: if you have changed the default IP Address assigned to the DI-624, make sure to enter the correct IP Address.

- Type **admin** in the **User Name** field
- Leave the **Password** blank
- Click **OK**

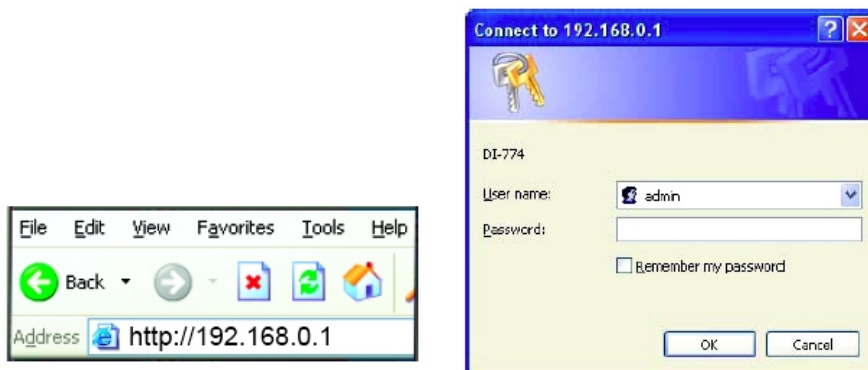

- The next step is to open ports within your router. Go to Virtual Server in the router.

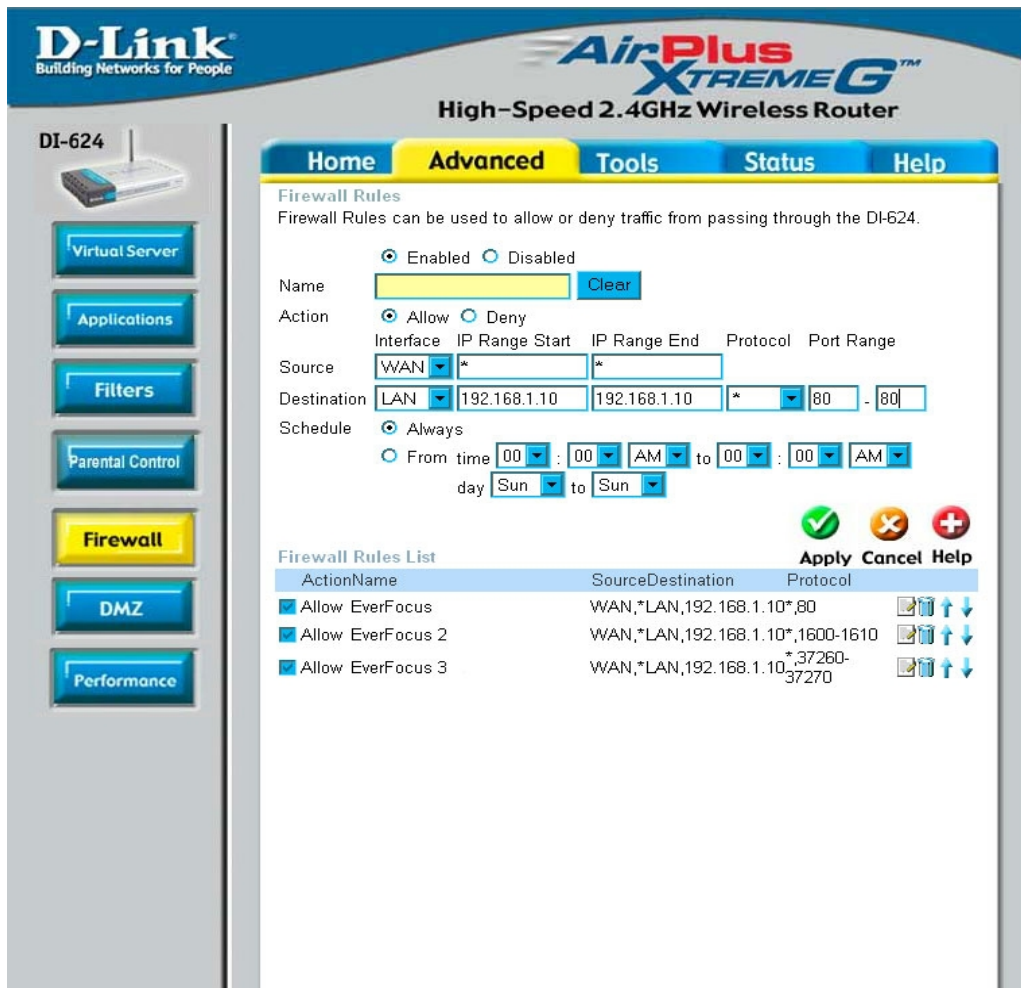

Example:

Firewall - Select Enabled or Disabled

Name - Enter the name referencing the virtual service

Action – Either Allow or Disallow its use.

Source - The server computer in the WAN (Wide Area Network) that will be providing the virtual services. If you have a Web server that you wanted Internet users to access at all times, you would need to enable it. Simply place a *.

Private IP - The server computer in the LAN (Local Area Network) that will be providing the virtual services. If you have a Web server that you wanted Internet users to access at all

times, you would need to enable it. Web (HTTP) server is on LAN (Local Area Network) computer 192.168.1.10 HTTP uses port 80, TCP and UDP.

Protocol Type - The protocol used for the virtual service.

Public Ports - The port number on the WAN (Wide Area Network) side that will be used to access the virtual service.

Schedule - The schedule of time when the virtual service will be enabled.

The schedule may be set to **Always**, which will allow the particular service to always be enabled. If it is set to **Time**, select the time frame for the service to be enabled. If the system time is outside of the scheduled time, the service will be disabled.

- The next step is to open ports within your router. Open virtual ports in the router.
 - EDR Ports to open: 80, 1600, 1601, 1602, 1603, 37260, 37261, 37262, 37263
 - *Note: If your Internet service provider blocks port 80 and you are using a different port to access the DVR through the DVR's Network Menu Setup please open those specific ports in this section of the router.*
 - *Note: If you wish to have multiple users log into the DVR please open a range for the control and data ports on your router. For example if you would only like 4 clients to connect to the DVR open 1600-1603 and 37260 ~ 37263*
- If your Internet Service Provider Blocks port 80. Simply do the following:
 - Change the HTTP port from 80 to 8100 in the **NETWORK MENU**.
- To access the DVR from a computer simply open Internet Explorer and in the address bar type:

The following is the address you would type:

http:// (IP address of your internet service provider): 8100

13. EverFocus DDNS Setup

*Note: You **MUST** have firmware version 1.6.2 or higher in order to use the EverFocus DDNS server.*

- Set up the Network Menu according to the instructions detailed in the Networking chapter.
- Go to the website <http://everfocusddns.com> and check for an available name.



The screenshot shows the EverFocus DDNS Service Site. The header includes the EverFocus logo and the text "DDNS SERVICE SITE" and "Welcome Guest!". The main content area is titled "Check Available Host Name" and features a text input field containing ".everfocusddns.com" and a "Check" button.

- In DVR's Network Menu, go to DDNS. Choose "everfocusddns.com" for the Server and put in your chosen name for DVR Name.

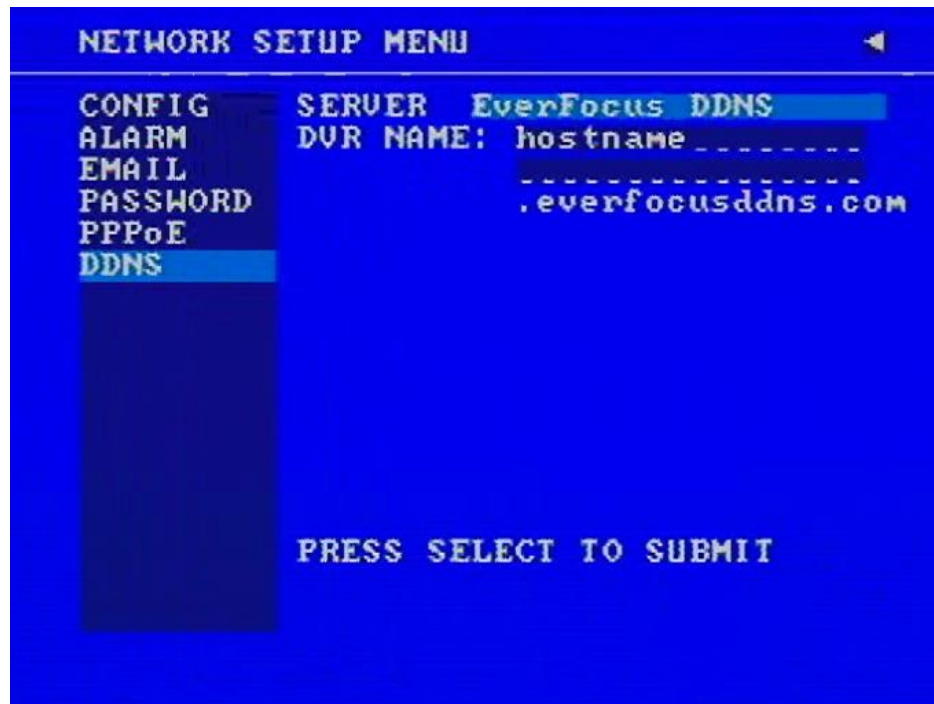

- Press the Select button to synchronize the DVR with the DDNS server. You should see the word "Success" at the bottom of the screen. If you see "Could Not Find Server" instead, double check your network settings until you get "Success".
- You should now be able to connect by typing in the host name you created.
Example: <http://hostname.everfocusddns.com>

14. Viewing through Internet Explorer

To access the DVR from a computer simply open Internet Explorer and in the address bar type:

http:// (LAN or IP address of your internet service provider)

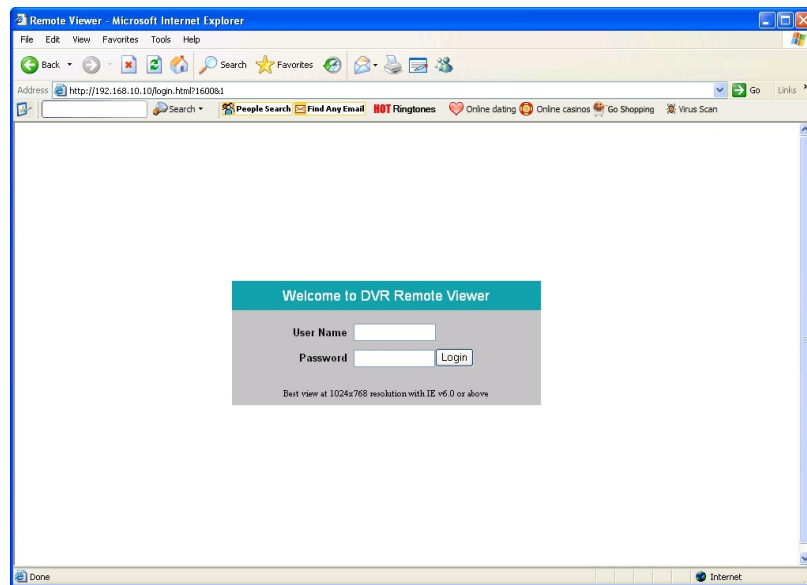

- The digital video login page will appear on the screen similar to the one shown above.
- User must enter a user name and password to access the recorder. You can find your user name and password in the Network setting menu of your DVR.
- The Default user name and password are admin and 11111111. (Remote user ID and Password can be found in the Network Menu)
- Then click on the submit button and you will be logged into your recorder.

➤ Installing ActiveX controls

When you first connect to the DVR's IP address, you will see a pop-up alert. Click OK to close the window.

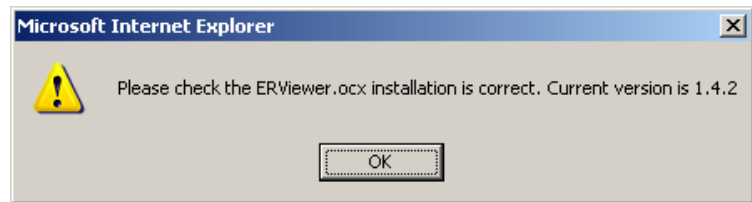

After a few seconds, you should see a screen like the one below. If you do not see a yellow bar like the one the arrow is pointing at, your security settings may be too high. If so, go to the section labeled "Enabling ActiveX Controls."

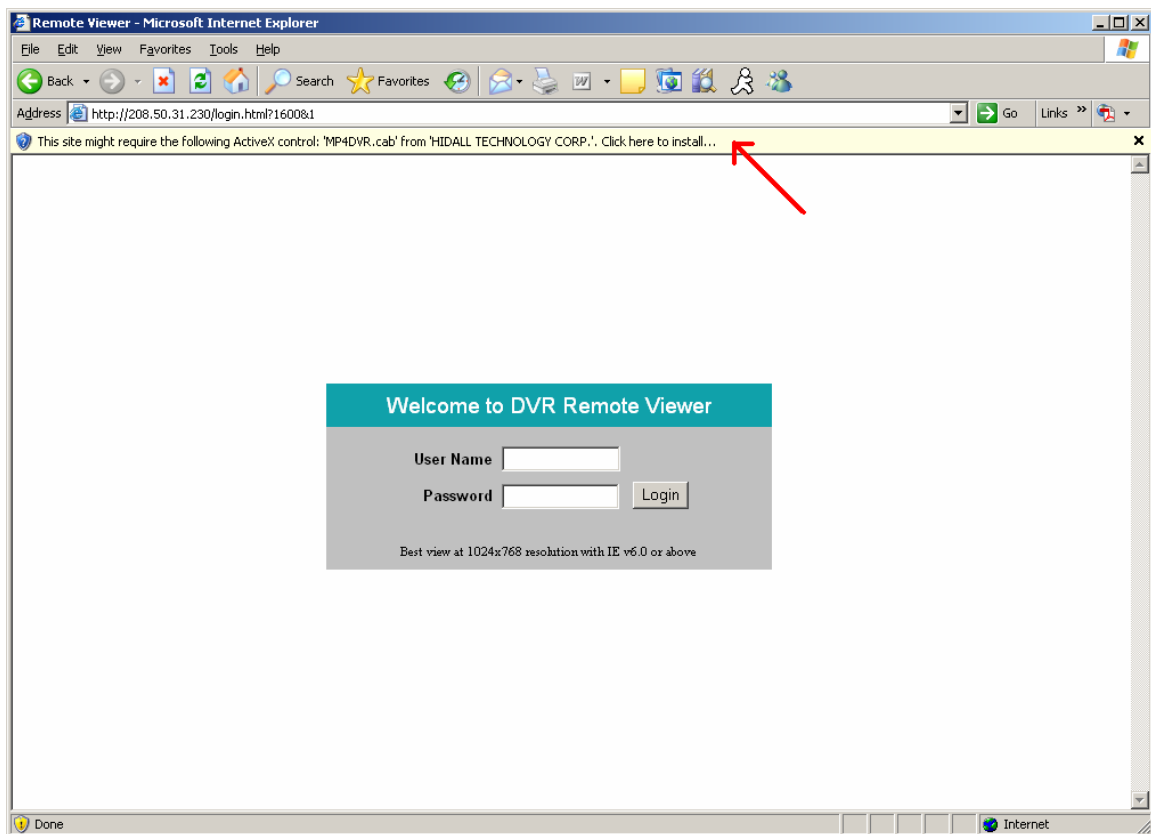

Right click on the yellow bar and select "Install ActiveX Control..."

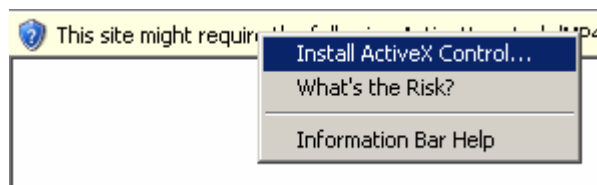

Install the MP4DVR file when prompted to do so.



Type in the username and password and click Login to view the cameras.

Default username: admin

Default password: 11111111

A screenshot of a web login page titled "Welcome to DVR Remote Viewer". The page has a teal header. Below the header, there are two input fields: "User Name" and "Password". To the right of the "Password" field is a "Login" button. At the bottom of the page, there is a note: "Best view at 1024x768 resolution with IE v6.0 or above".

➤ Enabling ActiveX Controls

Note: This section is only necessary if you **DO NOT** see the yellow ActiveX bar at the top of your browser screen.

At the top of the Internet Explorer Window, click on Tools, then select Internet Options.



Click the Security tab at the top of the window, then choose Custom Level near the bottom.

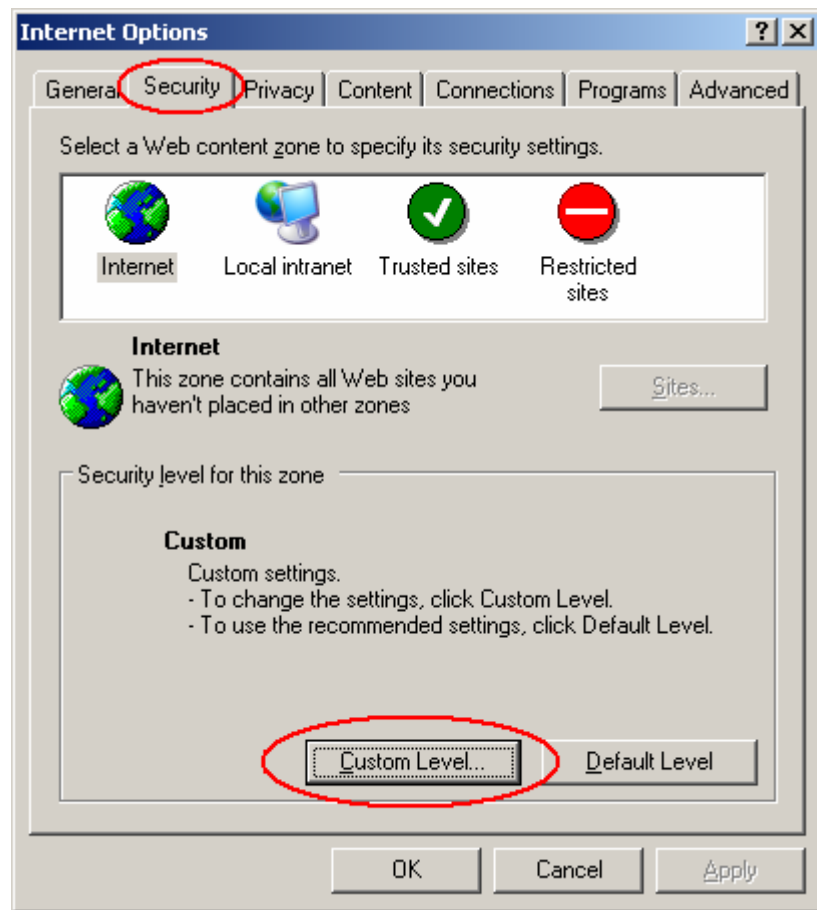

In the Security Settings window, scroll to “ActiveX controls and plug-ins”

Set the controls as follows:

“Enable”:

- ✓ Allow previously unused ActiveX controls to run without prompt (*Internet Explorer 7 only*)
- ✓ Allow scriptlets (*IE7 only*)
- ✓ Automatic prompting for ActiveX controls
- ✓ Binary and script behaviors
- ✓ Display video and animation on a webpage that does not use external media player (*IE7 only*)
- ✓ Run ActiveX controls and plug-ins
- ✓ Script ActiveX controls marked safe for scripting

“Prompt”:

- ✓ Download signed ActiveX controls
- ✓ Download unsigned ActiveX controls

“Disable”:

- ✓ Initialize and script ActiveX controls not marked as safe

Click OK and then choose Yes to change the security settings.

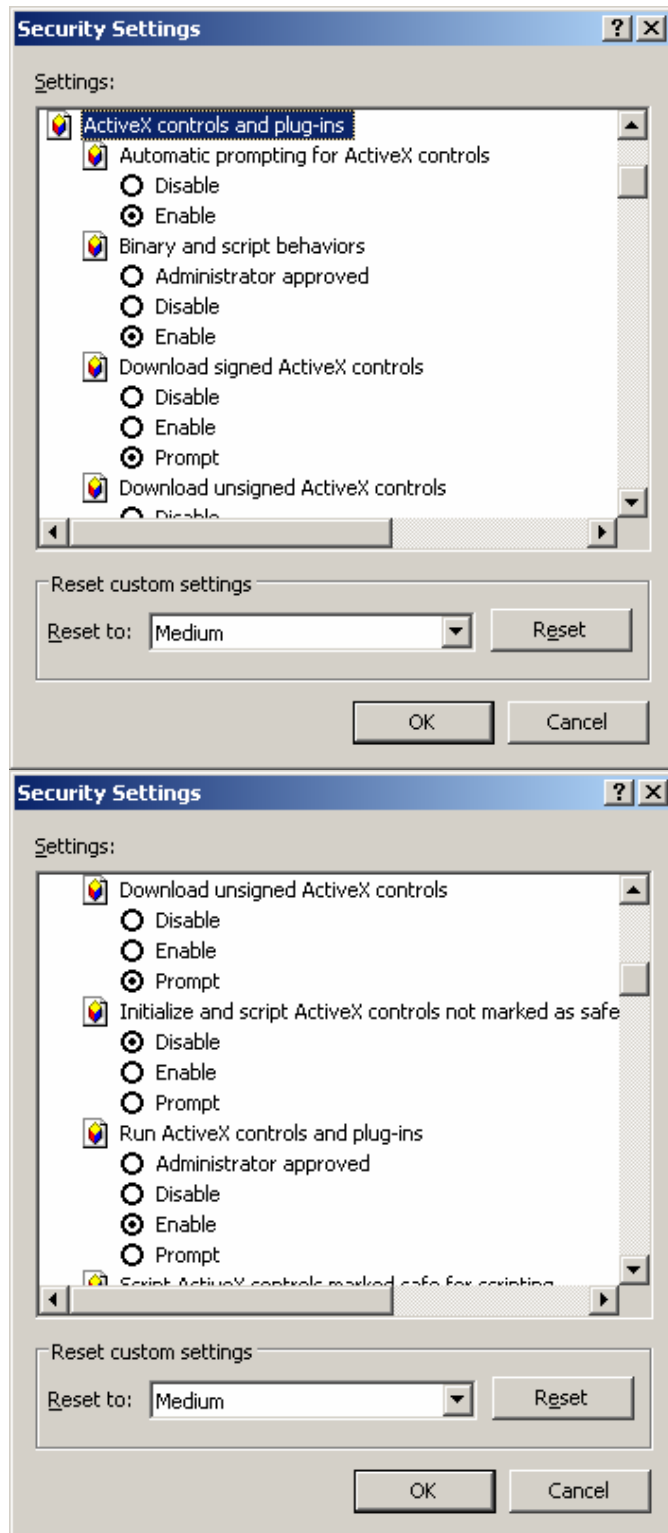

Close the window so you are back at the DVR Viewer screen.
Click the Refresh button to reload the page.



Install the MP4DVR file when prompted to do so.



Type in the username and password and click Login to view the cameras.
Default username: admin
Default password: 11111111



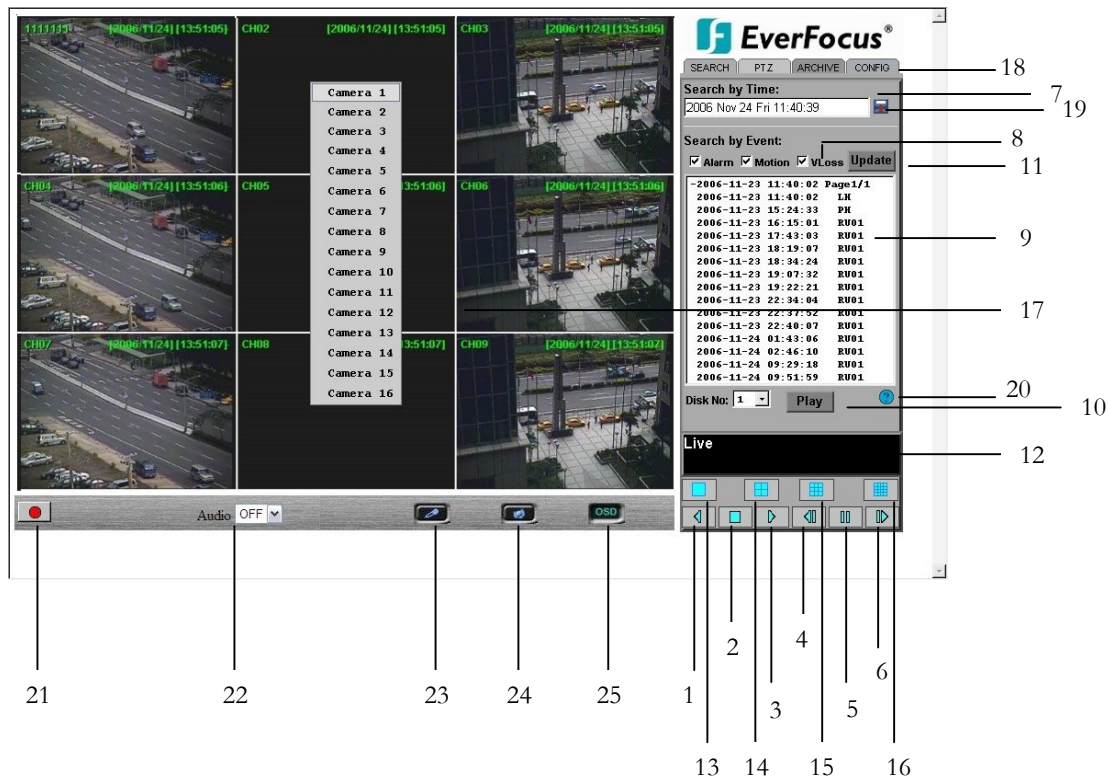



A screenshot of a web page titled "Welcome to DVR Remote Viewer". The page has a teal header with the title. Below the header, there are two input fields: "User Name" and "Password". To the right of the "Password" field is a "Login" button. At the bottom of the page, there is a note: "Best view at 1024x768 resolution with IE v6.0 or above".



The above diagram is the main screen display.

The icons on the lower corner of the screen are mainly for control and configuration; those on the right side are for status indication.

If any icon is grayed, it means that the specific function is not accessible in the current mode. The followings are a brief description for each of the icons.

1.  **REV. PLAY:** Reverse Video Playback.
2.  **STOP:** Press this key to stop Playback and return to Live mode.
3.  **PLAY:** Normal Video Playback.
4.  **STEP BACKWARD:** Move one frame back while paused.
5.  **PAUSE:** To pause the Video Playback display.
6.  **STEP FORWARD:** Move one frame forward while paused.

7. There are two methods of searching past video: by **Event** and by **Time**.
8. Types of events to be searched: **Alarm**, **Motion** and/or **Vloss**.
9. All available events are shown in the list. Click the desired event to highlight it.
10. Click on “**Play**” to play back highlighted video event.
11. Press “**Update**” to refresh the event list.
12. Current connection and playback status are shown along with date and time.
13. Full screen view.
14. Quad screen view.
15. Nine split screen view.
16. Sixteen split screen view.
17. If you right-click on a camera screen, a drop-down list of available cameras appears. Click on the desired camera to display it in that view screen.
18. There are 4 main functions of Remote Viewer: **SEARCH**, **PTZ**, **ARCHIVE** and **CONFIG**. **SEARCH** section allows you to search by event or by time. **PTZ** section allows you to control PTZ cameras. **ARCHIVE** section allows you to archive files or download DVRViewer. **CONFIG** section allows you to make system changes remotely.
19. **Date/Time Search**: Click on the blue box to open the detailed time search box.

20. Event Description: By clicking on the ⓘ sign, an event description list will show up as follow:

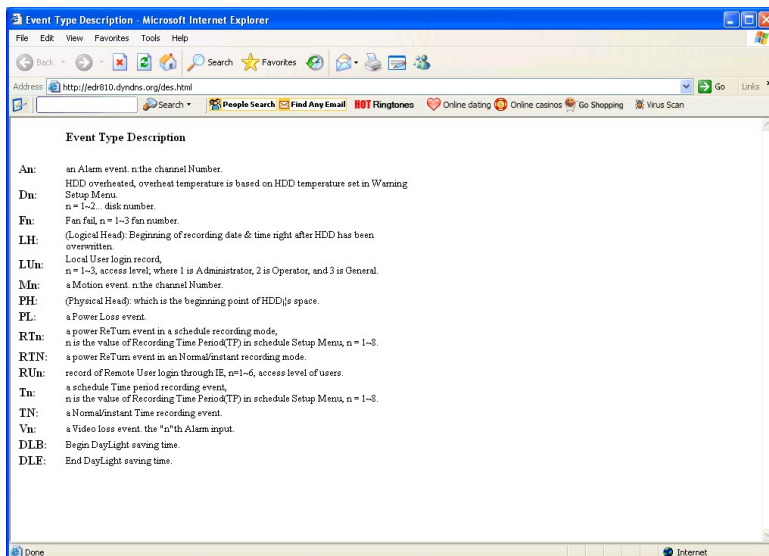

21. Record: Press the button to remotely activate the DVR's record function. Press again to stop recording.

22. Audio: This function allows you to transmit audio from DVR to your PC's remote site. Select audio source 1/2/3/4, or "OFF" to disable this function.

23. Audio Broadcast: This function is designed to transmit audio (through a microphone) to DVR that has speaker device installed. Keep this button pressed whenever you need to do audio broadcasting. Release this button to stop transmitting audio to DVR.

24. Relay Output: Press the button to trigger relay output.

25. OSD: Press to show OSD information, including camera name, date, time, and event type. Press again to hide them.

14.1 Search

14.1.1 Search by TIME

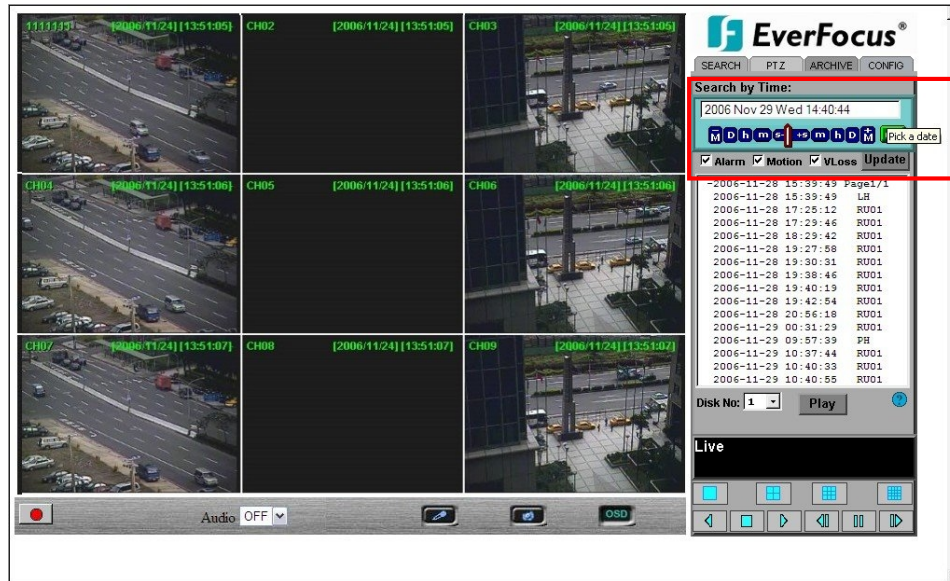

There are 3 ways to do search by time. Press  **Pick a date** first.

1. Press the **M** button to change the Month to be searched, **D** for day, **h** for hour, **m** for minute and **s** for second. The buttons on the left-hand side are to decrease the value, whereas those on the right-hand side are to increase the value.
2. Move the slide bar between the buttons to change Month, Day, Hour, Minute, and second to be searched. Move the slide bar to the left to decrease the value, or to the right to increase the value.
3. Enter Month, Day, Hour, Minute, and second directly in display bar. Press **OK** to start searching.



14.1.2 Search by EVENT



1. Select Event Type from **Alarm**, **Motion** and **Vloss**.

Note: Please keep at least one event type checked.

2. Select the **Disk No.** from which you would like to search events.
3. Press **Update** button to refresh the event list.
4. All events of the selected type will be displaying along with Date/Time, event type (represented by a capital letter), camera number (represented by a number)
For example, M02 is a motion event from camera 2.
5. When there is a “+” sign in front of the date with page number at the end, double-click to show all the events of that page.
6. Press **Play** button to playback the selected event.

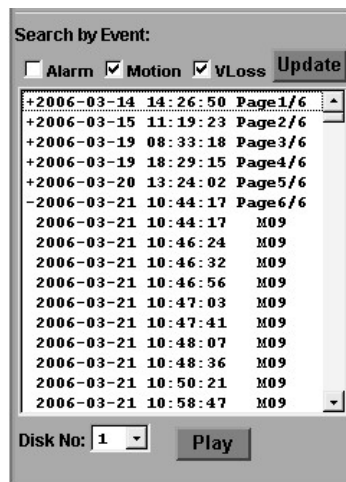

14.2 PTZ control

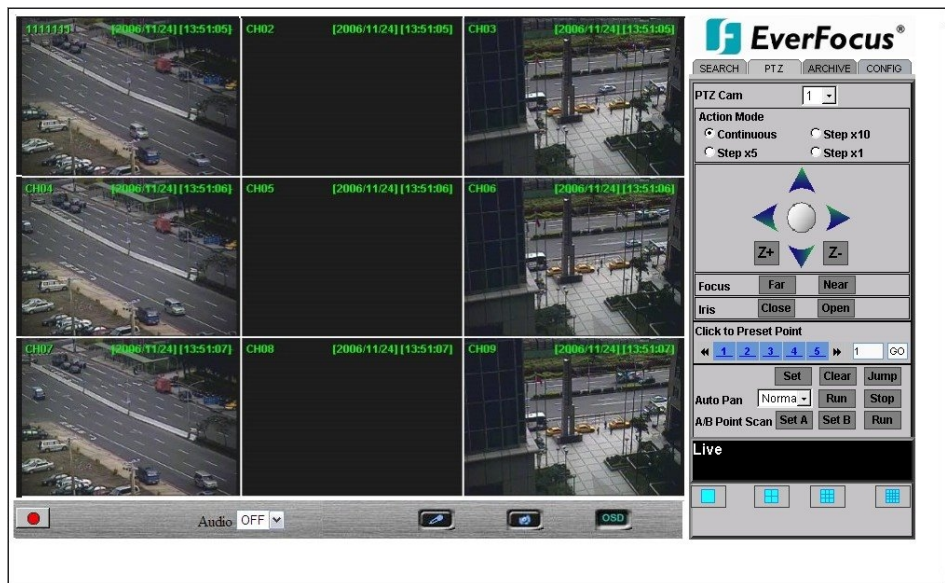

1. Select the PTZ camera from drop-down menu.
2. Select **Action Mode** you want to use. There are 4 options available: **Continuous**, **Step x10**, **Step x5** and **Step x1**.
3. Use Direction Arrows (up, down, left, right) to move/adjust the focus to your desired direction and angle.
4. Press **Z+** for Zooming In or **Z-** for Zooming Out.
5. In **Focus** option, press **Near** to move the focus closer to the subject or press **Far** to move the focus farther from the subject.
6. You can turn on the **Iris** by pressing **Open** or turn it off by pressing **Close**.
8. “**Click to Preset Point**” helps you to define the preset point you want the camera to look at. Press **Set** to confirm, **Clear** to delete or **Jump** to jump to a specific point.
9. “**Auto Pan**” is to define the speed of PTZ camera when moving horizontally. Choose from **Slower**, **Slow**, **Normal**, **Fast** to **Faster**. Press **Run** to start or **Stop** to end.
10. “**A/B Point Scan**” allows you to set a tour between 2 points. Move to the first point by using direction arrows and press **SET A**. Then move to the second point by using direction arrows and press **SET B**. Press **RUN** to start A/B Point Scan.

14.3 Remote Archive



To Archive files:

1. **Select Disk No.:** The hard drive you want to archive from
2. **Disk Storage Time: Start Time/End Time** indicates the start and end time of the selected disk
3. **Camera:** Select the camera that you wish to archive from.
4. **Start:** Select the start time of the archived video.
5. **End:** Select the end time of the archived video.

There are 3 ways to search **Start** or **End** time to be archived. First press

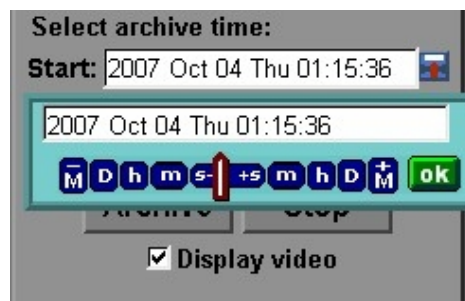

- 1) Press on the **M** button to change the Month to be searched, **D** for day, **h** for hour, **m** for minute and **s** for second. The buttons on the left side are to decrease the value, whereas those on the right side are to increase the value.

- 2) Move the slide bar between the buttons to change Month, Day, Hour, Minute, and second to be searched. Move the slide bar to the left to decrease the value, or to the right to increase the value.
 - 3) Enter Month, Day, Hour, Minute, and second directly in display bar.
 - 4) Press **OK** to select time.
6. Press **ARCHIVE** button to start archiving. An **“.arv”** file will be saved.
 7. Press **STOP** button if you wish to cancel archiving.
 8. Check **“Display video”**, if you wish to display what you are archiving on the screen while archiving file at same time.

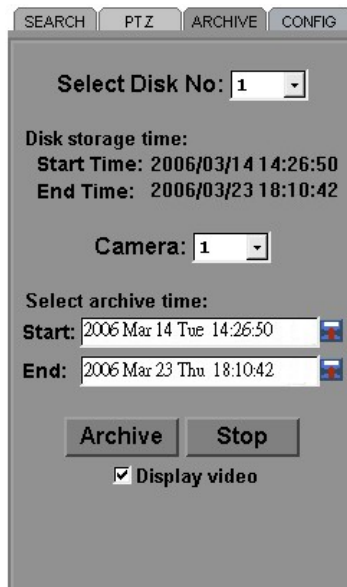

In order to play the archived EDR MPEG4 Files (.arv), you will need to download viewer:

1. Press **Download DVRViewer** button.

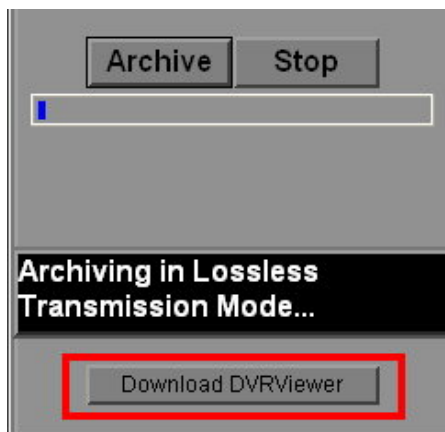

2. Select “**Run**” or “**Save**” the file.



3. Open the DVRViewer.exe for loading the archived EDR MPEG4 Files (.arv)

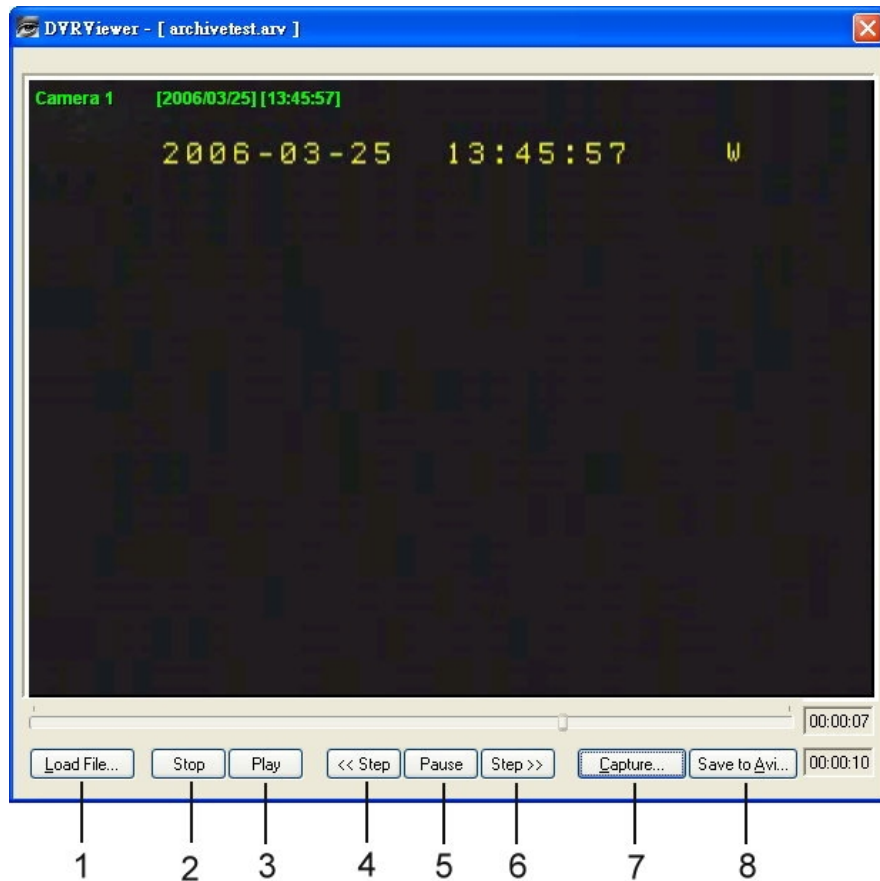

Detailed explanation of DVRViewer is as follows:

- i. **Load File:** to load the archived EDR MPEG4 Files (.arv).
- ii. **Stop:** to stop playing video.
- iii. **Play:** to play video.
- iv. **<<Step:** step backward after pausing.
- v. **Pause:** to pause playing.
- vi. **Step>>:** step forward after pausing.
- vii. **Capture:** to capture the current image as “.jpg” file.
- viii. **Save to Avi:** to save the archived EDR MPEG4 File as “.AVI” file.

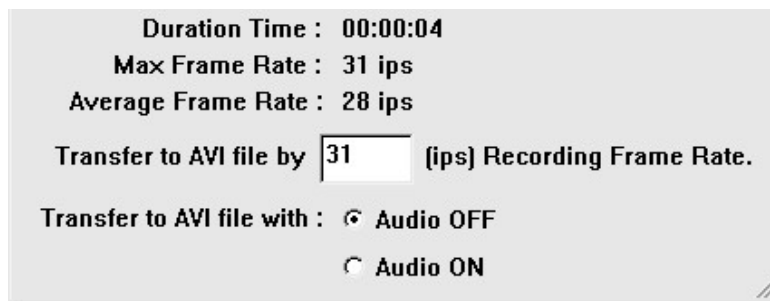

Note:

- (1) The recording frame rate will be automatically calculated. It is suggested to use the calculated Recording Frame Rate, although it is possible to change this value.
- (2) If you wish to save the audio recorded, please select **Audio ON**, so that the audio can be transferred to AVI file. Otherwise, select **Audio OFF**.

Note: If you are unable to play “AVI” file downloaded from “DVRViewer”, your PC may require a video codec.
The codec can be found at the following URL: <http://www.divx.com/divx/windows/codec/>
If you continue to have problems or are unable to download this file, you can also try <http://www.cole2k.net/?display=Codec-Pack-Advanced>

14.4 Remote Configuration



Click on the “CONFIG” tab to open a page where you can remotely change the DVR’s settings. Click on each option to go to the settings for that page.

When you finish making changes on a screen, press **Apply** to save the settings. Press **Reset** to display the DVR’s current menu settings.

The settings you make remotely in this page are virtually the same as the way you set up the DVR itself, except for as noted in the following pages.

DATE/TIME setup menu

⇒ **Set Date Time Infomation** Apply Reset

Time Format 24H 12H
Date Format

⇒ **Date Light Saving** Apply Reset

Enable
Start On
From To
End On
From To

⇒ **Set Time Synchronize** Apply Reset

Time Synchronize
Server IP
Time Zone
Time Update By

⇒ **Set Date Time Manually** Apply Reset



Set Date/Time Manually

1. Click on the calendar button to set Date/Time manually. A calendar will show up as shown below.
2. Click “<<” to decrease Year value, “>>” to increase Year value.
3. Click “<” to decrease Month value, “>” to increase Month value.
4. Click on the selected date directly.
5. Click on the Hour, Minute, Seconds to change Time value. Up arrow for increasing and Down arrow for decreasing the value. This is also used to change between Am and Pm.
6. Finally, click **Apply** to confirm setting.

<<	<	OCT 2007	>	>>		
Sun	Mon	Tue	Wed	Thu	Fri	Sat
		1	2	3	4	5
7	8	9	10	11	12	13
14	15	16	17	18	19	20
21	22	23	24	25	26	27
28	29	30	31			

Time  

[Apply](#)

CAMERA setup menu

⇒ **Set Camera Information** Apply Reset

Camera:
 Title: PTZ ID:
 Install: Main Monitor Seq.: Seconds
 Covert: Call Monitor Seq.: Seconds
 Quality:

Record Speed And Action

TP	Normal	Event	Action
1	<input type="text" value="1"/>	<input type="text" value="30"/>	<input checked="" type="checkbox"/>
2	<input type="text" value="1"/>	<input type="text" value="30"/>	<input checked="" type="checkbox"/>
3	<input type="text" value="1"/>	<input type="text" value="30"/>	<input checked="" type="checkbox"/>
4	<input type="text" value="1"/>	<input type="text" value="30"/>	<input checked="" type="checkbox"/>
5	<input type="text" value="1"/>	<input type="text" value="30"/>	<input checked="" type="checkbox"/>
6	<input type="text" value="1"/>	<input type="text" value="30"/>	<input checked="" type="checkbox"/>
7	<input type="text" value="1"/>	<input type="text" value="30"/>	<input checked="" type="checkbox"/>
8	<input type="text" value="1"/>	<input type="text" value="30"/>	<input checked="" type="checkbox"/>
Normal	<input type="text" value="1"/>	<input type="text" value="30"/>	<input checked="" type="checkbox"/>

RECORD setup menu

⇒ **Set Record Information** Apply Reset

Record Audio:
 Time Stamp:
 Time Stamp Position:
 Water Mark:
 Resolution:
 Rewrite:
 Auto Rewrite Within: Days
 Pre-Alarm Recording:
 Relay Out:

ALARM setup menu

⇒ **Set Alarm Information** Apply Reset

Alarm:
 Enable: Alarm Type:
 Log: Active Camera:
 PTZ Preset: Duration:
 Alarm Output: Alarm Email:
 Buzzer: Alarm Network:
 Main Monitor: Call Monitor:

MOTION setup menu

➔ Set Motion Information Apply Reset

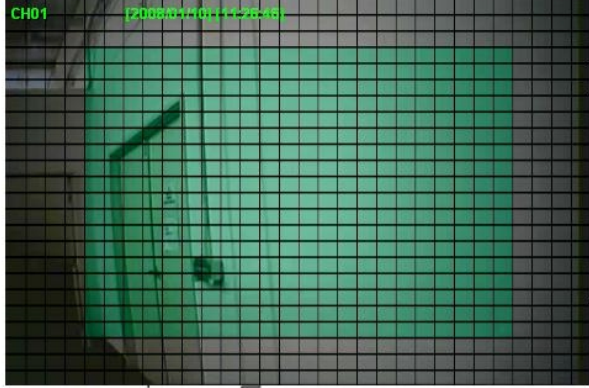

Camera: 1
Enable:
Log:
Alarm Output: NONE
Alarm Network:
Main Monitor: No Change
Motion Delay: 0 Level

Sensitivity: 7
Duration: 5 Seconds
Alarm Email:
Buzzer:
Call Monitor: No Change

Set Motion Grid

1. Non-green squares are disabled for motion; green squares are enabled.
2. Click and hold the mouse to begin selecting squares in the motion grid.
3. Drag the mouse to highlight the desired area.
4. The selected area will switch to the opposite color.
5. Click **Apply** to save the changes.

VIDEO LOSS setup menu

➔ Set Video Loss Information Apply Reset

Camera: 1
Enable:
Duration: 05 SEC
Alarm Output: NONE
Buzzer:

Log:
Alarm Email:
Alarm Network:

NETWORK 1 setup menu

Network Config Setting (Read Only) Reset			
IP Type	DHCP		
IP Address	192.168.1.148	Net Mask	255.255.255.0
Gateway	192.168.1.1	DNS Server	192.168.1.12
Remote Control	<input checked="" type="checkbox"/>		
HTTP Port	80	Control Port	1600
Data Port	37260	Band width	8192 KB

SMTP Setting Apply Reset	
SMTP Server	
Port No.	25
Authentication	<input type="checkbox"/>
Username	
Password	
Receiver	
Sender	

PPPOE Setting Apply Reset	
Username	
Password
Primary DNS	0.0.0.0
Secondary DNS	0.0.0.0

The Network Configuration Settings can not be changed remotely. These must be changed in the DVR's Network Menu.

NETWORK 2 setup menu

Alarm Network Setting Apply Reset			
Protocol	UDP	Port No.	1600
Unique ID		Server 1	192.168.1.100
Server 2	192.168.1.101	Server 3	192.168.1.102

Network Password Setting Apply Reset		
Account	Password	Level
ADMIN	Admin
USER2	Live
USER3	Live
USER4	Live
USER5	Live
USER6	Live

DDNS Setting Apply Reset	
Server	www.sitelutions.com
Username	
Password	
Record ID	
FQDN	

After saving changes to the account, password, or level, the changes will take effect the next time you log in to the network viewer.

SCHEDULE setup menu

Set Schedule Information					Apply	Reset
No.	Day	Start	End	Enable		
1.	Daily	00:00	00:00	<input type="checkbox"/>		
2.	Daily	00:00	00:00	<input type="checkbox"/>		
3.	Daily	00:00	00:00	<input type="checkbox"/>		
4.	Daily	00:00	00:00	<input type="checkbox"/>		
5.	Daily	00:00	00:00	<input type="checkbox"/>		
6.	Daily	00:00	00:00	<input type="checkbox"/>		
7.	Daily	00:00	00:00	<input type="checkbox"/>		
8.	Daily	00:00	00:00	<input type="checkbox"/>		

CONTROL setup menu

Control Setting				Apply	Reset
RS232 Setting					
Baud Rate	9600	Stop Bit	1		
Parity	None	Byte Size	8		
RS485 Setting					
Baud Rate	9600	Stop Bit	1		
Parity	None	Byte Size	8		
RS232/RS485 ID	1				
PTZ Protocol	Everfocus				

WARNING setup menu

Warning Fan Fault				Apply	Reset
Buzzer	<input checked="" type="checkbox"/>				
Alarm Output	1	Duration	Permanent		
Network Alarm	<input type="checkbox"/>	Send EMail	<input type="checkbox"/>		
Warning HDD Temp.				Apply	Reset
Buzzer	<input checked="" type="checkbox"/>				
Alarm Output	1	Duration	Permanent		
Network Alarm	<input type="checkbox"/>	Send EMail	<input type="checkbox"/>		
Stop Record	<input checked="" type="checkbox"/>	Temperature	60 °C		
			140 °F		
Warning No HDD				Apply	Reset
Buzzer	<input type="checkbox"/>				
Alarm Output	1	Duration	05 SEC		
Network Alarm	<input type="checkbox"/>	Send EMail	<input type="checkbox"/>		
Warning HDD Full				Apply	Reset
Buzzer	<input checked="" type="checkbox"/>				
Alarm Output	1	Duration	05 SEC		
Network Alarm	<input type="checkbox"/>	Send EMail	<input type="checkbox"/>		

SYSTEM setup menu

Update Firmware	Apply
Load Factory Default	Apply
Load/Save Configuration	Save Load

All recording should be stopped before making any changes on this menu.

Update Firmware

1. After clicking **Apply**, an “Open File” window appears.
2. Find the folder where the firmware upgrade is saved and choose Open.
3. On the DVR’s monitor, you will see a notice that the firmware is being updated.
Note: DO NOT try to open the menu or make changes at the DVR while this process is happening.
4. When the update is complete, the DVR will reboot automatically.
5. Once “Load System” has finished, the system’s software will be updated. You will need to refresh the network viewer for the changes to take effect.

Load/Save Configuration

1. Clicking **Save** will open a “Save File window.
2. Select the folder you wish to save the configuration file to and then choose Save.
3. Clicking **Load** will open an “Open File” window.
4. Find the folder where your configuration file is saved and then choose Open.

15. Interface Specifications

RS485

This Digital Video Recorder may be controlled by a computer or control keyboard (EKB500) via the RS485 interface. Pin definition of RS-485 connector on DVR back panel is shown in the following picture.

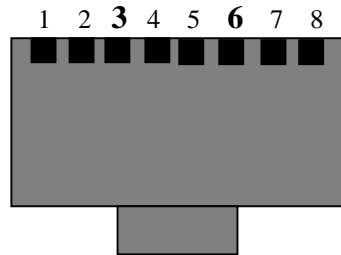

Pin 3: RS-485 +
Pin 6: RS-485 -

15.1 Transmission Setting

There are 6 different speeds that can be used to transmit instruction or information through the RS485 port on the device, 1200 baud, 2400 baud, 4800 baud, 9600 baud, 19200 baud, and 3840 baud. The default setting from the factory is 9600 baud.

15.2 Remote Control Protocol

A computer can be used to control the DVR by sending the packet as follows.

=====

EDR1640/1620/920 485 Control Code Protocol

=====

1-1. Sample control code packets

Example1: A packet that send "REC" key to EDR(ID=5)

0x85 (length)
0x00 (Receiver ID high byte)
0x05 (Receiver ID low byte)
0x4B (OPcode = key)
0x08 (DATA1 = "Rec" keycode)
0x5D (checksum)

Example2: A packet that send "PAUSE" key to EDR(ID=4999)

0x85 (length)
0x27 (Receiver ID high byte)
0x07 (Receiver ID low byte)
0x4B (OPcode = key)
0x0C (DATA1 = "Pause" keycode)
0x0A (checksum)

Example3: A packet that send "PLAY" key to all EDR(broadcast)

0x85 (length)
0x7f (Receiver ID high byte)
0x7f (Receiver ID low byte)

- 0x4B (OPcode = key)
- 0x0B (DATA1 = "Play" keycode)
- 0x59 (checksum)

2-1. The format of message packet is as follows:

- Length Byte (Prefix: 0x86, 0x87, or 0x88)
- Receiver ID high byte
- Receiver ID low byte
- Opcode Byte
- Data Byte1
- Data Byte2
- Data Byte3
- .
- .
- Checksum Byte

2-2. Length Byte

This Length Byte is also a prefix. Bit7 must be 1.

EX: 0x87 ==> this packet has 7 bytes length. (not included Length byte itself)

2-3. Receiver ID

1). Individual receiver ID

Decimal 14bit binary value Hbyte Lbyte Receiver ID

----- ----- -----

0 0000000 0000000 00 00 ID = 0

1	0000000 0000001	00	01	ID = 1
2	0000000 0000010	00	02	ID = 2
....				
126	0000000 1111110	00	7e	ID = 126
127	0000000 1111111	00	7f	ID = 127
128	0000001 0000000	01	00	ID = 128
129	0000001 0000001	01	01	ID = 129
255	0000001 1111111	01	7f	ID = 255
256	0000010 0000000	02	00	ID = 256
....				
511	0000011 1111111	03	7f	ID = 511
....				
16382	1111111 1111110	7f	7e	ID = 16382

2). Broadcast ID

Decimal	14bit binary value	Hbyte	Lbyte	Receiver ID
---------	--------------------	-------	-------	-------------

16383	1111111 1111111	7f	7f	All EDR connect to RS485/RS232
-------	-----------------	----	----	--------------------------------

2-4. Opcode Byte & Data bytes

2-4-1. OPcode

OPcode	Data1	Function
--------	-------	----------

0x4B Keycode A remote key pressed

2-4-1. A remote key pressed (OPcode=0x4B)

Data1 Key

0x00	CH1	0x0E	COPY
0x01	CH2	0x0F	DISPLAY
0x02	CH3	0x10	SHUTTLE<<0
0x03	CH4	0x11	SHUTTLE<<1
0x04	MODE	0x12	SHUTTLE<<2
0x05	ZOOM	0x13	SHUTTLE<<3
0x06	SEQ	0x14	SHUTTLE<<4
0x07	MENU	0x15	SHUTTLE<<5
0x08	REC	0x16	SHUTTLE<<6
0x09	REV.PLAY	0x17	SHUTTLE>>0
0x0A	STOP	0x18	SHUTTLE>>1
0x0B	PLAY	0x19	SHUTTLE>>2
0x0C	PAUSE	0x1a	SHUTTLE>>3
0x0D	SEARCH	0x1b	SHUTTLE>>4
0x1c	SHUTTLE>>5	0x29	CH 14
0x1d	SHUTTLE>>6	0x2a	CH 15
0x1e	JOG<	0x2b	CH 16

0x1f	JOG>	0x2c	SELECT
0x20	CH5	0x2d	CALL
0x21	CH6	0x2e	ENTER
0x22	CH7	0x2f	(reserved)
0x23	CH8	0x30	(reserved)
0x24	CH9	0x31	(reserved)
0x25	CH 10	0x32	(reserved)
0x26	CH 11	0x33	(reserved)
0x27	CH 12	0x34	(reserved)
0x28	CH 13		

2-5. Checksum Byte

Checksum is computed as the sum of all previous bytes (including the length byte), then mask with 0x7f.

Appendix A: Remote Control

The remote controller (RC200, Diagram A1) is an accessory to enhance the handy operations of the DVR. You can perform all the settings and operations by the remote controller. The effective distances are up to 10 meters without any obstacle. The keypad functions are same as the front panel key button of the DVR.

There are some replacement keys for JOG and SHUTTLE, definitions are:

JOG ► : Same as turning the JOG clockwise.

JOG ◀ : Same as turning the JOG counter-clockwise.

SHUTTLE ►►

- 1: fast forward 2X or slow forward 1/2X.
- 2: fast forward 4X or slow forward 1/4X.
- 3: fast forward 8X or slow forward 1/8X.
- 4: fast forward 16X or slow forward 1/10X.
- 5: fast forward 32X or slow forward 1/16X.
- 6: fast forward 600X or slow forward 1/32X.

SHUTTLE ◀◀

- 1: fast rewind 2X or slow rewind 1/2X.
- 2: fast rewind 4X or slow rewind 1/4X.
- 3: fast rewind 8X or slow rewind 1/8X.
- 4: fast rewind 16X or slow rewind 1/10X.
- 5: fast rewind 32X or slow rewind 1/16X.
- 6: fast rewind 600X or slow rewind 1/32X.

Note: The channel keys #10~16 are not available.

Reserved only for 16 CH DVR.

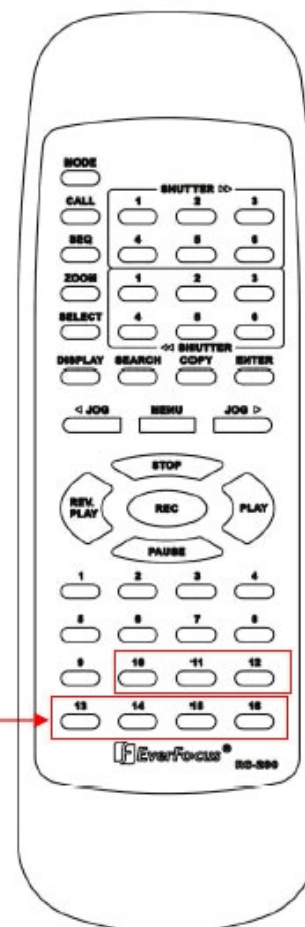

Diagram A1

Appendix B: Mouse Installation

To use a PS2 mouse with the DVR simply turn off the DVR first. Then plug in a **PS2 Optical mouse with Scroll Wheel** to the PS2 Mouse port on the back of the DVR. When you power the DVR back up the mouse will have been loaded and you will see a mouse cursor on your screen.

B-1 Using the Mouse

To bring up the mouse playback menu scroll the mouse to the middle of your screen and the playback menu will appear. You will then be able to click one of several buttons to play back, stop, forward, and rewind. To see the options menu using the mouse simply right click anywhere on your screen and you will see a menu similar to Diagram B1.

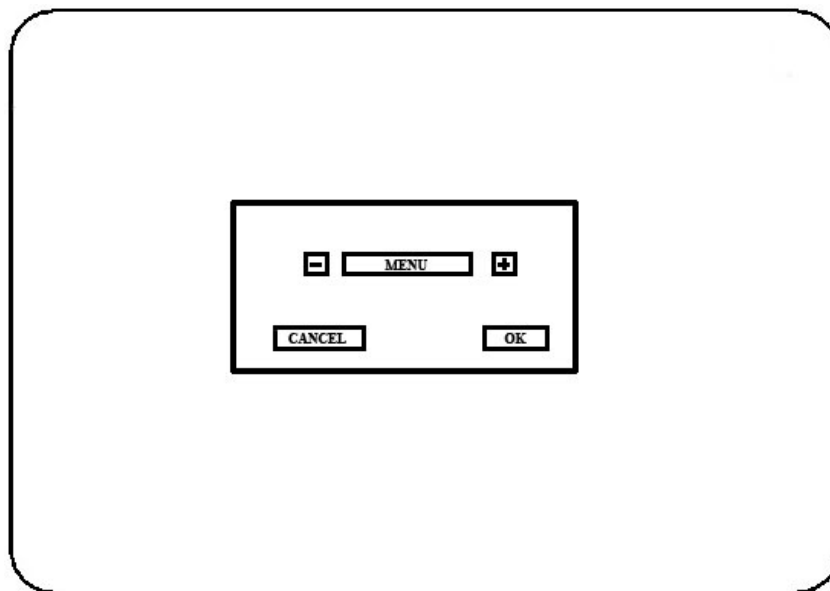

Diagram B1

You can click on the + or - boxes to go through the options or use your scroll wheel on the mouse. This menu gives you the following options:

- Mode, All Single Channel Views, Copy, Search, Stop, Menu, Display, Call, Select, Sequence, Zoom.

When you select any one of these options and press ok, it will be the same as pressing one of the options on the front panel of your DVR. Once you have logged into the menu option or any other

option a new menu will appear. For example Diagram B2 shows an example of a new menu once you have clicked ok for the menu.



Diagram B2

From this menu you can left click on any one of the menu to select that menu.

CAMERA SETUP MENU					
CAMERA 1	TITLE	CH01			
CAMERA 2	PTZ ID	011			
CAMERA 3	INSTALL/COVERT	ON /OFF			
CAMERA 4	SEQ(MAIN/CALL)	03/03 SECS			
CAMERA 5	REC QUALITY	SUPERIOR			
CAMERA 6					
CAMERA 7	REC SPEED &	ACTION			
CAMERA 8	TP	NORMAL	EVENT	ACTION	
CAMERA 9	1	7.5 IPS	30 IPS	ON	
CAMERA 10	2	7.5 IPS	30 IPS	ON	
CAMERA 11	3	7.5 IPS	30 IPS	ON	
CAMERA 12	4	7.5 IPS	30 IPS	ON	
CAMERA 13	5	7.5 IPS	30 IPS	ON	
CAMERA 14	6	7.5 IPS	30 IPS	ON	
CAMERA 15	7	7.5 IPS	30 IPS	ON	
CAMERA 16	8	7.5 IPS	30 IPS	ON	
SUMMARY	N	7.5 IPS	30 IPS	ON	

Diagram B3

To go back to your main screen from here simply click on the Back arrow located on the top right hand of this screen.

Appendix C: Alarm Board Configuration

The alarm connector, **Figure 1**, is used to provide one sensor alarm input for each camera input. For easy operation, an alarm extension board, **Figure 2**, is provided to connect to the alarm connector.

Each alarm input requires two wires, one wire connects to the desired alarm input pin, the second wire connects to the ground. The alarm signal assignment is shown at the following.

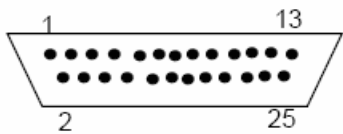

<Figure 1>

D-SUB 25 pin female connector (DVR)

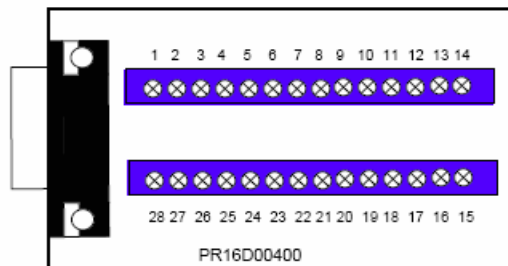

<Figure 2>

PR16D00400 Alarm extension board (HOST).

DVR	
PIN #	NAME
1	GND
2	ALM 1
3	ALM 2
4	ALM 3
5	ALM 4
6	ALM 5
7	ALM 6
8	ALM 7
9	ALM 8
10	ALM 9
11	RESERVED
12	RESERVED
13	RESERVED
14	RESERVED
15	RESERVED
16	RESERVED
17	RESERVED
18	ALMRSTO
19	REC
20	GIN10
21	DISKFULL
22	GO1
23	ALM-N.C
24	ALM-N.O
25	ALM-COM

HOST	
PIN #	NAME
1	GND
2	ALM 1
3	ALM 2
4	ALM 3
5	ALM 4
6	ALM 5
7	ALM 6
8	GND
9	ALM 7
10	ALM 8
11	ALM 9
12	ALM10
13	ALM 11
14	ALM 12
15	ALM 13
16	ALM 14
17	ALM 15
18	ALM 16
19	ALMRST
20	REC-IN
21	GND
22	SPARE-IN
23	DISKFULL
24	SPARE-OUT
25	ALM-N.C
26	ALM-N.O
27	ALM-COM
28	GND

ALM10~ALM16 are reserved only for 16 CH DVR.

Appendix D: Lapse Mode Recording Table

EDR1640 – D1 model

720*480

NTSC		Unit: Hour											
Recording Speed (IPS)	PICTURE QUALITY (KB)												
	LOWER		LOW		BASIC		STANDARD		HIGH		SUPERIOR		
	simple	complex	simple	complex	simple	complex	simple	complex	simple	complex	simple	complex	
	8.04	12.33	8.42	13.7	10.15	16.72	11.86	19.56	14.72	24.63	18.6	30.05	
120	71.98	46.93	68.73	42.24	57.02	34.61	48.79	29.59	39.31	23.50	31.11	19.26	
96	89.97	58.67	85.91	52.80	71.27	43.26	60.99	36.98	49.14	29.37	38.89	24.07	
80	108	70.40	103.09	63.36	85.52	51.92	73.19	44.38	58.97	35.24	46.67	28.89	
64	135	88.00	128.87	79.20	106.90	64.90	91.49	55.47	73.71	44.05	58.34	36.11	
48	179.9	117.34	171.82	105.60	142.54	86.53	121.99	73.97	98.29	58.74	77.78	48.15	
32	269.9	176.00	257.74	158.40	213.81	129.79	182.98	110.95	147.43	88.11	116.67	72.22	
16	539.8	352.01	515.47	316.81	427.61	259.59	365.96	221.90	294.86	176.22	233.35	144.44	

720*576

PAL		Unit: Hour											
Recording Speed (IPS)	PICTURE QUALITY (KB)												
	LOWER		LOW		BASIC		STANDARD		HIGH		SUPERIOR		
	simple	complex	simple	complex	simple	complex	simple	complex	simple	complex	simple	complex	
	8.04	12.33	8.42	13.7	10.15	16.72	11.86	19.56	14.72	24.63	18.6	30.05	
100	86.37	56.32	82.48	50.69	68.42	41.53	58.55	35.50	47.18	28.20	37.34	23.11	
80	108	70.40	103.09	63.36	85.52	51.92	73.19	44.38	58.97	35.24	46.67	28.89	
64	135	88.00	128.87	79.20	106.90	64.90	91.49	55.47	73.71	44.05	58.34	36.11	
48	179.9	117.34	171.82	105.60	142.54	86.53	121.99	73.97	98.29	58.74	77.78	48.15	
32	269.9	176.00	257.74	158.40	213.81	129.79	182.98	110.95	147.43	88.11	116.67	72.22	
16	539.8	352.01	515.47	316.81	427.61	259.59	365.96	221.90	294.86	176.22	233.35	144.44	

EDR1640 – Half D1 model

720*240

NTSC		Unit: Hour											
Recording Speed (IPS)	PICTURE QUALITY (KB)												
	LOWER		LOW		BASIC		STANDARD		HIGH		SUPERIOR		
	simple	complex	simple	complex	simple	complex	simple	complex	simple	complex	simple	complex	
	3.53	7.82	3.87	8.36	4.21	8.9	4.92	9.54	5.62	10.17	6.41	12.89	
240	81.97	37.00	74.77	34.61	68.73	32.51	58.81	30.33	51.49	28.45	45.14	22.45	
160	123	55.50	112.15	51.92	103.09	48.77	88.22	45.50	77.23	42.68	67.71	33.67	
120	163.9	74.00	149.54	69.22	137.46	65.02	117.62	60.66	102.97	56.90	90.28	44.90	
96	204.9	92.50	186.92	86.53	171.82	81.28	147.03	75.83	128.72	71.13	112.85	56.12	
80	245.9	111.00	224.30	103.83	206.19	97.53	176.43	90.99	154.46	85.35	135.42	67.34	
64	307.4	138.76	280.38	129.79	257.74	121.92	220.54	113.74	193.07	106.69	169.28	84.18	
48	409.8	185.01	373.84	173.06	343.65	162.56	294.06	151.65	257.43	142.26	225.70	112.24	
32	614.8	277.51	560.76	259.59	515.47	243.84	441.09	227.48	386.15	213.39	338.56	168.36	
16	1230	555.02	1121.52	519.17	1030.94	487.67	882.17	454.96	772.29	426.77	677.11	336.72	

720*288

PAL		Unit: Hour											
Recording Speed (IPS)	PICTURE QUALITY (KB)												
	LOWER		LOW		BASIC		STANDARD		HIGH		SUPERIOR		
	simple	complex	simple	complex	simple	complex	simple	complex	simple	complex	simple	complex	
	3.53	7.82	3.87	8.36	4.21	8.9	4.92	9.54	5.62	10.17	6.41	12.89	
200	98.36	44.40	89.72	41.53	82.48	39.01	70.57	36.40	61.78	34.14	54.17	26.94	
160	123	55.50	112.15	51.92	103.09	48.77	88.22	45.50	77.23	42.68	67.71	33.67	
120	163.9	74.00	149.54	69.22	137.46	65.02	117.62	60.66	102.97	56.90	90.28	44.90	
96	204.9	92.50	186.92	86.53	171.82	81.28	147.03	75.83	128.72	71.13	112.85	56.12	
80	245.9	111.00	224.30	103.83	206.19	97.53	176.43	90.99	154.46	85.35	135.42	67.34	
64	307.4	138.76	280.38	129.79	257.74	121.92	220.54	113.74	193.07	106.69	169.28	84.18	
48	409.8	185.01	373.84	173.06	343.65	162.56	294.06	151.65	257.43	142.26	225.70	112.24	
32	614.8	277.51	560.76	259.59	515.47	243.84	441.09	227.48	386.15	213.39	338.56	168.36	
16	1230	555.02	1121.52	519.17	1030.94	487.67	882.17	454.96	772.29	426.77	677.11	336.72	

360*240

NTSC		Unit: Hour											
Recording Speed (IPS)	PICTURE QUALITY (KB)												
	LOWER		LOW		BASIC		STANDARD		HIGH		SUPERIOR		
	simple	complex	simple	complex	simple	complex	simple	complex	simple	complex	simple	complex	
	1.76	4.56	1.87	4.87	1.97	5.46	2.38	6.51	2.67	7.08	3.63	9.02	
480	82.2	31.73	77.37	29.71	73.44	26.50	60.79	22.22	54.19	20.43	39.86	16.04	
320	123.3	47.59	116.05	44.56	110.16	39.75	91.18	33.34	81.28	30.65	59.78	24.06	
240	164.4	63.45	154.73	59.42	146.88	52.99	121.58	44.45	108.37	40.87	79.71	32.08	
200	197.3	76.15	185.68	71.30	176.25	63.59	145.89	53.34	130.05	49.04	95.65	38.49	
160	246.6	95.18	232.10	89.12	220.32	79.49	182.36	66.67	162.56	61.30	119.57	48.12	
120	328.8	126.91	309.47	118.83	293.76	105.99	243.15	88.89	216.74	81.74	159.42	64.16	
96	411	158.64	386.83	148.54	367.20	132.49	303.94	111.12	270.93	102.17	199.28	80.20	
80	493.2	190.36	464.20	178.25	440.64	158.98	364.73	133.34	325.11	122.61	239.13	96.24	
64	616.5	237.95	580.25	222.81	550.80	198.73	455.91	166.68	406.39	153.26	298.92	120.30	
48	822	317.27	773.67	297.08	734.40	264.97	607.88	222.24	541.86	204.34	398.56	160.39	
32	1233	475.91	1160.50	445.61	1101.59	397.46	911.82	333.35	812.79	306.52	597.83	240.59	
16	2466	951.82	2321.00	891.23	2203.19	794.92	1823.65	666.71	1625.57	613.03	1195.67	481.18	

360*288

PAL		Unit: Hour											
Recording Speed (IPS)	PICTURE QUALITY (KB)												
	LOWER		LOW		BASIC		STANDARD		HIGH		SUPERIOR		
	simple	complex	simple	complex	simple	complex	simple	complex	simple	complex	simple	complex	
	1.76	4.56	1.87	4.87	1.97	5.46	2.38	6.51	2.67	7.08	3.63	9.02	
400	98.64	38.07	92.84	35.65	88.13	31.80	72.95	26.67	65.02	24.52	47.83	19.25	
320	123.3	47.59	116.05	44.56	110.16	39.75	91.18	33.34	81.28	30.65	59.78	24.06	
240	164.4	63.45	154.73	59.42	146.88	52.99	121.58	44.45	108.37	40.87	79.71	32.08	
160	246.6	95.18	232.10	89.12	220.32	79.49	182.36	66.67	162.56	61.30	119.57	48.12	
120	328.8	126.91	309.47	118.83	293.76	105.99	243.15	88.89	216.74	81.74	159.42	64.16	
96	411	158.64	386.83	148.54	367.20	132.49	303.94	111.12	270.93	102.17	199.28	80.20	
80	493.2	190.36	464.20	178.25	440.64	158.98	364.73	133.34	325.11	122.61	239.13	96.24	
64	616.5	237.95	580.25	222.81	550.80	198.73	455.91	166.68	406.39	153.26	298.92	120.30	
48	822	317.27	773.67	297.08	734.40	264.97	607.88	222.24	541.86	204.34	398.56	160.39	
32	1233	475.91	1160.50	445.61	1101.59	397.46	911.82	333.35	812.79	306.52	597.83	240.59	
16	2466	951.82	2321.00	891.23	2203.19	794.92	1823.65	666.71	1625.57	613.03	1195.67	481.18	

720*480

NTSC		Unit: Hour											
Recording Speed (IPS)	PICTURE QUALITY (KB)												
	LOWER		LOW		BASIC		STANDARD		HIGH		SUPERIOR		
	simple	complex	simple	complex	simple	complex	simple	complex	simple	complex	simple	complex	
	8.04	12.33	8.42	13.7	10.15	16.72	11.86	19.56	14.72	24.63	18.6	30.05	
60	144	93.87	137.46	84.48	114.03	69.22	97.59	59.17	78.63	46.99	62.23	38.52	
48	179.9	117.34	171.82	105.60	142.54	86.53	121.99	73.97	98.29	58.74	77.78	48.15	
32	269.9	176.00	257.74	158.40	213.81	129.79	182.98	110.95	147.43	88.11	116.67	72.22	
16	539.8	352.01	515.47	316.81	427.61	259.59	365.96	221.90	294.86	176.22	233.35	144.44	

720*576

PAL		Unit: Hour											
Recording Speed (IPS)	PICTURE QUALITY (KB)												
	LOWER		LOW		BASIC		STANDARD		HIGH		SUPERIOR		
	simple	complex	simple	complex	simple	complex	simple	complex	simple	complex	simple	complex	
	8.04	12.33	8.42	13.7	10.15	16.72	11.86	19.56	14.72	24.63	18.6	30.05	
50	172.7	112.64	164.95	101.38	136.84	83.07	117.11	71.01	94.35	56.39	74.67	46.22	
48	179.9	117.34	171.82	105.60	142.54	86.53	121.99	73.97	98.29	58.74	77.78	48.15	
32	269.9	176.00	257.74	158.40	213.81	129.79	182.98	110.95	147.43	88.11	116.67	72.22	
16	539.8	352.01	515.47	316.81	427.61	259.59	365.96	221.90	294.86	176.22	233.35	144.44	

EDR1620/920 – Half D1 model

720*240

NTSC		Unit: Hour											
Recording Speed (IPS)	PICTURE QUALITY (KB)												
	LOWER		LOW		BASIC		STANDARD		HIGH		SUPERIOR		
	simple	complex	simple	complex	simple	complex	simple	complex	simple	complex	simple	complex	
	3.53	7.82	3.87	8.36	4.21	8.9	4.92	9.54	5.62	10.17	6.41	12.89	
120	163.9	74.00	149.54	69.22	137.46	65.02	117.62	60.66	102.97	56.90	90.28	44.90	
96	204.9	92.50	186.92	86.53	171.82	81.28	147.03	75.83	128.72	71.13	112.85	56.12	
80	245.9	111.00	224.30	103.83	206.19	97.53	176.43	90.99	154.46	85.35	135.42	67.34	
64	307.4	138.76	280.38	129.79	257.74	121.92	220.54	113.74	193.07	106.69	169.28	84.18	
48	409.8	185.01	373.84	173.06	343.65	162.56	294.06	151.65	257.43	142.26	225.70	112.24	
32	614.8	277.51	560.76	259.59	515.47	243.84	441.09	227.48	386.15	213.39	338.56	168.36	
16	1230	555.02	1121.52	519.17	1030.94	487.67	882.17	454.96	772.29	426.77	677.11	336.72	

720*288

PAL		Unit: Hour											
Recording Speed (IPS)	PICTURE QUALITY (KB)												
	LOWER		LOW		BASIC		STANDARD		HIGH		SUPERIOR		
	simple	complex	simple	complex	simple	complex	simple	complex	simple	complex	simple	complex	
	3.53	7.82	3.87	8.36	4.21	8.9	4.92	9.54	5.62	10.17	6.41	12.89	
100	196.7	88.80	179.44	83.07	164.95	78.03	141.15	72.79	123.57	68.28	108.34	53.87	
96	204.9	92.50	186.92	86.53	171.82	81.28	147.03	75.83	128.72	71.13	112.85	56.12	
80	245.9	111.00	224.30	103.83	206.19	97.53	176.43	90.99	154.46	85.35	135.42	67.34	
64	307.4	138.76	280.38	129.79	257.74	121.92	220.54	113.74	193.07	106.69	169.28	84.18	
48	409.8	185.01	373.84	173.06	343.65	162.56	294.06	151.65	257.43	142.26	225.70	112.24	
32	614.8	277.51	560.76	259.59	515.47	243.84	441.09	227.48	386.15	213.39	338.56	168.36	
16	1230	555.02	1121.52	519.17	1030.94	487.67	882.17	454.96	772.29	426.77	677.11	336.72	

EDR1620/920 – CIF model

360*240

NTSC		Unit: Hour											
Recording Speed (IPS)	PICTURE QUALITY (KB)												
	LOWER		LOW		BASIC		STANDARD		HIGH		SUPERIOR		
	simple	complex	simple	complex	simple	complex	simple	complex	simple	complex	simple	complex	
	1.76	4.56	1.87	4.87	1.97	5.46	2.38	6.51	2.67	7.08	3.63	9.02	
240	164.4	63.45	154.73	59.42	146.88	52.99	121.58	44.45	108.37	40.87	79.71	32.08	
200	197.3	76.15	185.68	71.30	176.25	63.59	145.89	53.34	130.05	49.04	95.65	38.49	
160	246.6	95.18	232.10	89.12	220.32	79.49	182.36	66.67	162.56	61.30	119.57	48.12	
120	328.8	126.91	309.47	118.83	293.76	105.99	243.15	88.89	216.74	81.74	159.42	64.16	
96	411	158.64	386.83	148.54	367.20	132.49	303.94	111.12	270.93	102.17	199.28	80.20	
80	493.2	190.36	464.20	178.25	440.64	158.98	364.73	133.34	325.11	122.61	239.13	96.24	
64	616.5	237.95	580.25	222.81	550.80	198.73	455.91	166.68	406.39	153.26	298.92	120.30	
48	822	317.27	773.67	297.08	734.40	264.97	607.88	222.24	541.86	204.34	398.56	160.39	
32	1233	475.91	1160.50	445.61	1101.59	397.46	911.82	333.35	812.79	306.52	597.83	240.59	
16	2466	951.82	2321.00	891.23	2203.19	794.92	1823.65	666.71	1625.57	613.03	1195.67	481.18	

360*288

PAL		Unit: Hour											
Recording Speed (IPS)	PICTURE QUALITY (KB)												
	LOWER		LOW		BASIC		STANDARD		HIGH		SUPERIOR		
	simple	complex	simple	complex	simple	complex	simple	complex	simple	complex	simple	complex	
	1.76	4.56	1.87	4.87	1.97	5.46	2.38	6.51	2.67	7.08	3.63	9.02	
200	197.3	76.15	185.68	71.30	176.25	63.59	145.89	53.34	130.05	49.04	95.65	38.49	
160	246.6	95.18	232.10	89.12	220.32	79.49	182.36	66.67	162.56	61.30	119.57	48.12	
120	328.8	126.91	309.47	118.83	293.76	105.99	243.15	88.89	216.74	81.74	159.42	64.16	
96	411	158.64	386.83	148.54	367.20	132.49	303.94	111.12	270.93	102.17	199.28	80.20	
80	493.2	190.36	464.20	178.25	440.64	158.98	364.73	133.34	325.11	122.61	239.13	96.24	
64	616.5	237.95	580.25	222.81	550.80	198.73	455.91	166.68	406.39	153.26	298.92	120.30	
48	822	317.27	773.67	297.08	734.40	264.97	607.88	222.24	541.86	204.34	398.56	160.39	
32	1233	475.91	1160.50	445.61	1101.59	397.46	911.82	333.35	812.79	306.52	597.83	240.59	
16	2466	951.82	2321.00	891.23	2203.19	794.92	1823.65	666.71	1625.57	613.03	1195.67	481.18	

Note: The above recording tables are calculated based on 250 GB of system storage.

Terms of Use

The HDD size required in your DVR may vary from this calculated test result under some conditions. Total storage capacity may vary depending on complexity of video scenes, DVR specifications and features used on the actual installation sites. Test results and information obtained from these tables are furnished for informational use only. It is user's responsibility to test and allocate appropriate HDD size for his/her DVR systems.

Troubleshooting

If you have difficulty operating your system, run through the following checklist to see if you can solve the problem.

- **The DVR will not go into record mode?**
 - Make sure the HDD is locked in with the keys. Also check to make sure the hard drives are set to Master. A diagram located on the Hard Drive Label will show you how to set the drive to master.

- **The DVR displays no picture?**
 - First question you should ask yourself is the equipment wired properly. Please see your installation manual for help.
 - The second question to ask yourself, do all the wires used work properly.
 - The next step is to verify the recorder is getting the correct amount of power.

- **There is no display coming from one of the channels on the DVR?**
 - The first step is to verify is the problem coming from the recorder or the camera.
 - Simply take a working camera and plug it into the port that seems to not be working. If you see a picture this means the problem is coming from the camera.

- **I cannot connect to the recorder via the internet?**
 - The first thing to check is does your internet provider block any ports.
 - Are you using the IP address from the Internet Service provider?
 - If you are using a router are the ports in your router opened?

EverFocus Electronics Corp.

Head Office:

12F, No.79 Sec. 1 Shin-Tai Wu Road,
Hsi-Chih, Taipei, Taiwan
TEL: +886-2-26982334
FAX: +886-2-26982380
www.everfocus.com.tw

USA Office:

1801 Highland Ave. Unit A
Duarte, CA 91010, U.S.A.
TEL: +1-626-844-8888
FAX: +1-626-844-8838
www.everfocus.com

USA N.Y. Office:

415 Oser Avenue Unit S
Hauppauge, NY 11788
TEL: 631-436-5070
FAX: 631-436-5027
www.everfocus.com

Europe Office:

Albert-Einstein-Strasse 1
D-46446 Emmerich, Germany
TEL: 49-2822-9394-0
www.everfocus.de

China Office:

Room B-05D-1, KESHI PLAZA , Shangdi
Information Industry Base, Haidian District,
Beijing China 100085
TEL: +86-10-62973336/37/38/39
FAX: +86-10-62971423
www.everfocus.com.cn

Japan Office:

1809 WBG MARIBU East 18F,
2-6 Nakase.Mihama-ku.
Chiba city 261-7118, Japan
TEL : +81-43-212-8188
FAX : +81-43-297-0081
www.everfocus.com

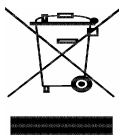

Your EverFocus product is designed and manufactured with high quality materials and components which can be recycled and reused. This symbol means that electrical and electronic equipment, at their end-of-life, should be disposed of separately from your household waste. Please, dispose of this equipment at your local community waste collection/recycling centre. In the European Union there are separate collection systems for used electrical and electronic product. Please, help us to conserve the environment we live in!

Ihr EverFocus Produkt wurde entwickelt und hergestellt mit qualitativ hochwertigen Materialien und Komponenten, die recycelt und wieder verwendet werden können. Dieses Symbol bedeutet, dass elektrische und elektronische Geräte am Ende ihrer Nutzungsdauer vom Hausmüll getrennt entsorgt werden sollen. Bitte entsorgen Sie dieses Gerät bei Ihrer örtlichen kommunalen Sammelstelle oder im Recycling Centre. Helfen Sie uns bitte, die Umwelt zu erhalten, in der wir leben!



EverFocus®

P/N: MR61G0010D_Ver.H